

# INDEX

2	<b>COMPANY PROFILE</b> WELCOME TO SOLARIS
	<b>PRODUCTS</b>
4	R&D BENCHTOP FERMENTERS/ BIOREACTORS
6	IO
14	JUPITER
26	VENUS
36	ELARA ST
44	ELARA FLAT
52	GENESIS
60	SINGLE USE FERMENTERS/ BIOREACTORS
68	PILOT AND INDUSTRIAL FERMENTERS/ BIOREACTORS
70	M SERIES
78	S-I SERIES
96	PRODUCTS AND SERVICES
98	PROCESS PLANTS
102	METIS GAS ANALYSER
104	KRONOS TF FILTRATION
112	TYTAN
114	C.I.P. & S.I.P. SYSTEMS
116	EDUCATION & TRAINING
117	FERMENTATION AND BIOTECH DEVELOPMENT

# COMPANY PROFILE

## WELCOME TO SOLARIS

Solaris is a dynamic company founded in 2002, with customers located around the globe. Our mission entails providing customers with innovative process solutions through carefully tailored products. We value close customer collaboration which helps maximize efficiency and thus return on investment. Our customers range from startup labs, public and private R&D institutes, to well established manufacturers within the biotech, pharmaceutical, food&beverage industries. We offer technology at virtually every scale, allowing customers to grow within our offerings.



Solaris provides design and manufacturing expertise in many bioprocess disciplines. This gives unique capabilities associated with standalone systems, but also the ability to integrate process steps into complete turnkey plants. Our engineering, sales and support teams work closely with customers throughout project feasibility studies, engineering, manufacturing, installation, and thereafter with continued after-sales support. Solaris products include fermenters, bioreactors, chemical reactors, gas analysers, CIP/SIP systems, upstream process systems, downstream tangential flow filtration systems (micro-filtration, ultrafiltration, nanofiltration, reverse osmosis) and more. Solaris' headquarters and production facilities are located in the northern Italian region of Lombardy, with local representation in more than 40 countries worldwide.

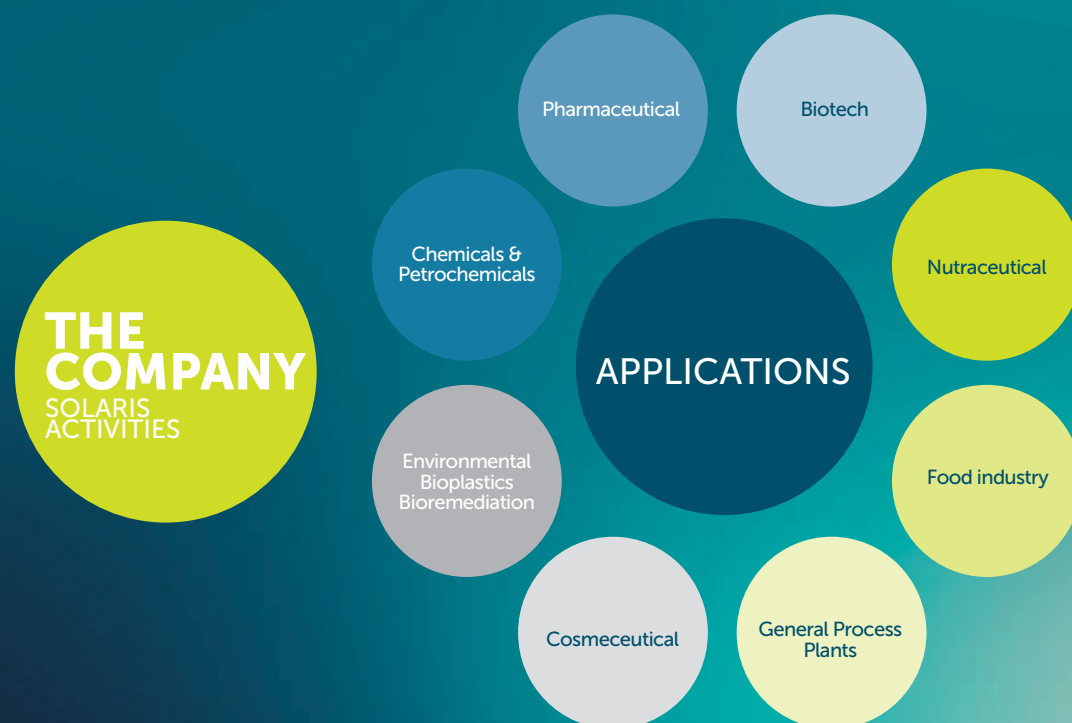



# PRODUCTS

## R&D BENCHTOP FERMENTERS/BIOREACTORS

Solaris benchtop fermenters and bioreactors offer efficient platforms for R&D and product development applications. These systems are designed to be straight forward yet extremely flexible, offering a multitude of options. Benefits include compact and user-friendly designs, integration of state of the art components and ancillary technology, a powerful and intuitive parallel software platform, up to date and open communication protocols, and more.

Benchtop systems are available in autoclave, single use and/or SIP vessel platforms, and configurable for each application and organism. These systems are also designed to easily scale to pilot and industrial platforms.

**IO**



**JUPITER**



**VENUS**



**ELARA ST**



**ELARA FLAT**

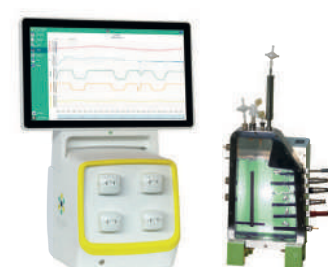

**GENESIS**

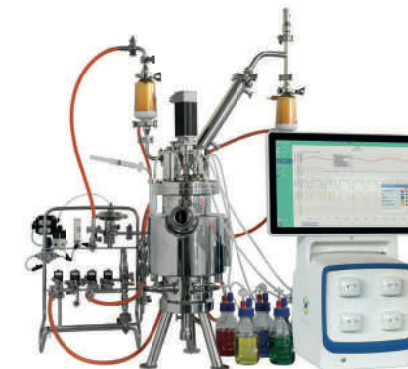

**BLACKJAR & BLACKBOX**



# SINGLE & PARALLEL MINI FERMENTERS/BIOREACTORS

# 10

**IO**, the smallest scale Solaris platform, offers 200 ml and 1000 ml total volume autoclavable vessel sizes. The system utilizes innovative Leonardo software, capable of managing up to 24 systems in parallel.



**IO** typical applications includes the following:  
Education & Basic research  
Scale-up and scale-down studies  
Process development and optimization

**IO** can be used for:  
Biopharmaceutical  
Biofuels  
Food industry  
Bioremediation  
Bioplastic  
Cosmeceutical  
Nutraceutical

**WHY TO INVEST  
IN THIS PRODUCT**

**Fast and accurate  
thermoregulation  
without  
water  
circulation**

**Parallel control  
up to 24 units**



## Benefits

Up to 24 units managed with one HMI with innovative PARALLEL process control  
LEONARDO: smart controller designed to provide a high level of automated management of the fermentation/cultivation processes

Batch, Fed batch or continuous processes

Different gas mixing strategies with up to 5 TMFC

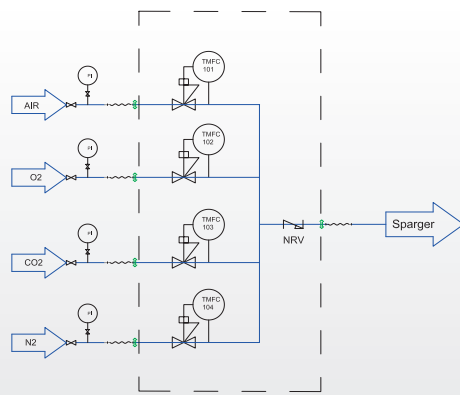

24" HMI

Remote control via PC, tablet and smartphone for process management and after sale assistance

Powerful/ Accurate **brushless motor**, from 1 to 2000 RPM. Online absorbed Torques (Nm) and Power (W) measurements obtaining an indirect density indication of the culture broth

Modbus Digital sensors



No water circulation: Thermoregulation performed through Peltier cell



LEDA safe sterile sampling system  
The needle free connector is designed to reduce the risk of contamination during sampling.  
The sterile combination of a syringe (3-5-10-30 ml) and a non return valve guarantees the sterility after sampling until the next use.



Compact and modular PCS

Additional parameter in modular external boxes for future PCS upgrade Including dCO<sub>2</sub>, cell density, weight, peristaltic pumps, ect



N.4 assignable Watson Marlow pumps in entry level

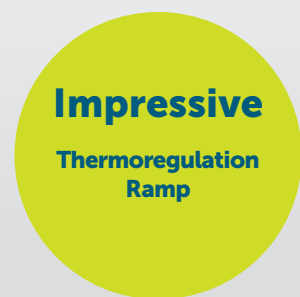
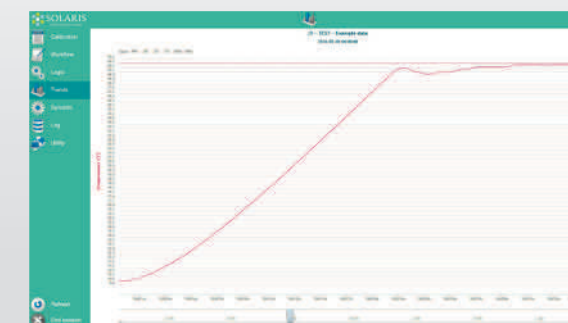

# SINGLE & PARALLEL MINI FERMENTERS/BIOREACTORS

## Modbus Digital sensors

### Why a digital sensor?

Digital sensors (including Cell Density products) have been integrated to the Solaris PCS and Leonardo controlling software, giving the user many benefits over traditional analog sensor outputs. Such benefits include a robust communication protocol not susceptible to signal loss, in-software sensor diagnostic information, parallel calibration/batch calibrations and more.



Sensor life traceability

Reducing background noise

## Smart PCS



Solaris new modular product design strategy decreases time to market and the number of unique parts in the product architecture, increasing the number of product variants. The result is a lean, flexible and smart PCS, which can be stacked in case of parallel processes through a dedicated support.

Optimize Lab Space!

Additional parameters in modular external boxes for future PCS upgrade including dCO<sub>2</sub>, Cell Density, Weight, Peristaltic pumps, ect.



## Leonardo 3.0

### USER-FRIENDLY SOFTWARE

Solaris controlling software offers a simply laid out, yet powerful platform for experimental design planning and process control. The graphical user interface enables the intuitive selection and adjustment of control functions. Extracted data is compatible with Window Excel but, in addition, Solaris offers a platform where fermentation data can be easily exported in real time and thus managed. This software is included in the supply and can be installed on an unlimited number of the client's PC or laptops.

### Do it parallel: smarter..faster



Leonardo allows intuitive and time-saving parallel operations. Up to 24 independent fermentations/cultivations can be carried out simultaneously.

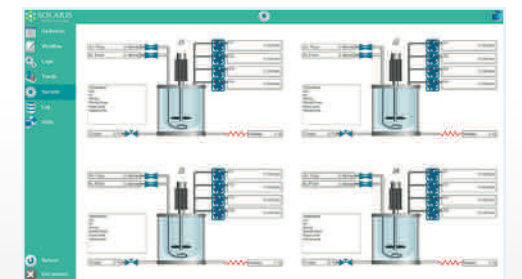

Parallel synoptic.

### Do it wireless!



Increase mobility: users have the option to access the platform remotely, via PC, tablet, phone. Remote access is multi-level password protected.



## Data sheet

Vessel		
Solaris Code	IO 200	IO 1000
Total Volume (ml)	200	1000
Ratio H/D	1:1,5	1:2,5
Min. Working Volume (ml)	120	250
Max. Working Volume (ml)	150	750
Max. temperature	70 °C	
Max Operating pressure	0,9 bar (g)	
Material	Borosilicate glass and AISI 316 L	
Headplate Ports (n.8 IO 200, N.10 IO 1000)	IO 200: n.3 PG13.5 (sensors, gas out condenser, multifeed), n.2 ports DN8 (gas in sparger, harvest/sampling), n.3 DN9 (gas out, antifoam probe, level probe, single feed) IO 1000: n.5 PG13.5 (sensors, gas out condenser, multifeed, level probe), n.5 ports DN9 (gas in sparger, harvest, sampling, gas out, antifoam probe, single feed)	
Sensors length (mm)		
length	120	225
Dimensions for autoclave (with condenser)		
Height (mm)	280	380
Diameter (mm)	170	150
Stirring		
Drive	Brushless Motor, 1-2000 rpm	
Power	100 W	
Impellers	Select from: Rushtons impellers, Marine Impellers, Pitched blade	
Thermoregulation		
Control	PID control - accuracy 0,1°C - Peltier Cell	
Gas Control & Gas Mixing		
Sparger and overlay Gas Control	TMFC	
Gas Mixing (Air,CO <sub>2</sub> ,O <sub>2</sub> ,N <sub>2</sub> )	1TMFC (included in entry level) +4 solenoid valves or + n. of additional TMFC	
Sparger type	Fluted with laser microholes provided with 0,2 µm filter	
Exhaust	0,2 µm filter	
Peristaltic Pumps		
	n.4 Watson Marlow type 114, fixed speed, max. 60 rpm, volumetric flow 0,5-51 ml/min, function assignable from software	
Controller		
PCS	from 1 to 24 units - H: 350mm L: 350mm D: 350mm	
HMI with Leonardo software	24"	

## Controls

pH	
Sensor	Digital sensor
Sensitivity	57 to 59 mV/pH
Control system	Measuring resident in Leonardo 3.0 software
Control range	0 - 14
Operation temperature	0 - 130°C
Pressure range	0 - 6 bar
Actuator	Cascade to peristaltic pumps for the addition of acid/base solutions or gas (CO <sub>2</sub> )
dO <sub>2</sub>	
Sensor	Digital Optical sensor
Accuracy	±0.05%-vol, 21±0.2%-vol, 50±0.5%-vol
Control system	Measuring resident in Leonardo 3.0 software
Control range	0,05 - 300% air saturation
Operation temperature	-10 - 130°C
Pressure range	0 - 12 bar
Actuator	Cascade to RPM, Gas Control, feedings,ect
Redox (ORP)	
Sensor	Digital sensor
Sensitivity	57 to 59 mV/pH
Control system	Measuring resident in Leonardo 3.0 software
Operation temperature	- 10 -130°C
Pressure range	≤ 6 bar
Control range	±2000 mV
Antifoam/Level	
Sensor	Solaris sensor
Control	Measuring resident in Leonardo 3.0 software
Conductivity	
Sensor	Digital sensor
Accuracy	±3% at 1 µS/cm to 100 mS/cm, ± 5% at 100 to 300 mS/cm
Control system	Measuring resident in Leonardo 3.0 software
Operation temp	0 -130°C
Pressure range	0 - 20 bar
Control range	1 - 3000 µS/cm

dCO <sub>2</sub>	
Sensor	Analog sensor
Accuracy	±10% (pCO <sub>2</sub> 10-900 mbar) ≥ ± 10%
Control system	Measuring resident in Leonardo 3.0 software
Operation temperature	-20.0-150°C
Control range	0 - 4 bar(g)
Cell density	
Sensor	Digital sensor
Accuracy	Mammalian cells in suspension ± 5·10 <sup>4</sup> cells/ml - Fermentation ± 0.05 g/l dry weight
Control system	Measuring resident in Leonardo 2.0 software
Option 1	Dencytee: Total cell density based on turbidity (10 <sup>4</sup> to 10 <sup>8</sup> mammalian cells/ml- 0.5 to 100 g/L dry weight)
Option 2	Incyte: Viable cell density based on capacitance (5x10 <sup>4</sup> to 8x10 <sup>8</sup> mammalian cells/ml-5 to 200 g/L dry weight)
Weight	
Sensor	Digital balance
Accuracy	±0.1 g
Control	Measuring resident in Leonardo 3.0 software
Peristaltic pumps	
WM 313 FDM/D	175 rpm

MODULAR EXTERNAL BOX

INTEGRATED IN THE PCS



**UP TO 8  
FERMENTERS  
CONNECTED!**

# SINGLE & PARALLEL FERMENTERS/BIOREACTORS

## JUPITER

The **JUPITER** platform offers multiple autoclavable vessel sizes and designs from 2 up to 10 L total volume. Various aspect ratios and thermoregulation designs are also available. The system is highly configurable, built with high quality components, and offered at a competitive price with no strings attached. Jupiter is available both jacketed and single-wall (**Jupiter SW**).

**JUPITER** typical applications includes the following:  
Education & Basic research  
Scale-up and scale-down studies  
Process development and optimization

**JUPITER** can be used for:  
Biopharmaceutical  
Biofuels  
Food industry  
Bioremediation  
Bioplastic  
Cosmeceutical  
Nutraceutical



**WHY TO  
INVEST  
IN THIS PRODUCT**

The best ratio  
**Quality/  
Capability/Price**  
on the market

**Parallel control**  
up to **24 units**



## Benefits

Up to 24 units managed with one HMI with innovative PARALLEL process control LEONARDO: smart controller designed to provide a high level of automated management of the fermentation/cultivation processes  
Batch, Fed batch or continuous processes

Powerful/ Accurate **brushless motor**, from 1 to 2000 RPM.  
Online absorbed Torques (Nm) and Power (W) measurements obtaining an indirect density indication of the culture broth.

Modbus Digital sensors



LEDA safe sterile sampling system

Safety: pressure relief valve included in each unit

Compact and modular PCS

Additional parameter in modular external boxes for future PCS upgrade including dCO<sub>2</sub>, cell density, weight, peristaltic pumps, ect



N.4 assignable Watson Marlow pumps in entry level

Wide range of options, 5 different volumes and 2 different ratio H/D

Jacketed (fully removable and cleanable) or single wall, with heating blanket and cooling finger (Jupiter SW)

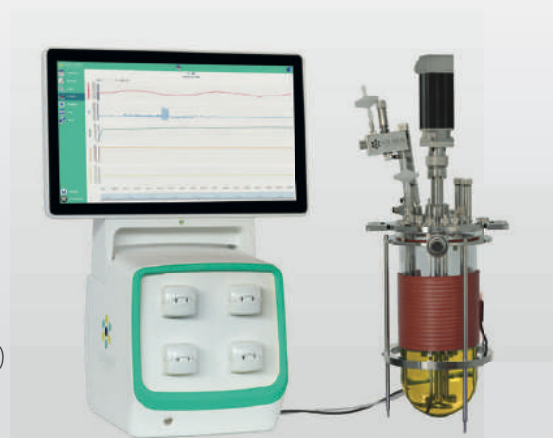

Different gas mixing strategies with up to 5 TMFC

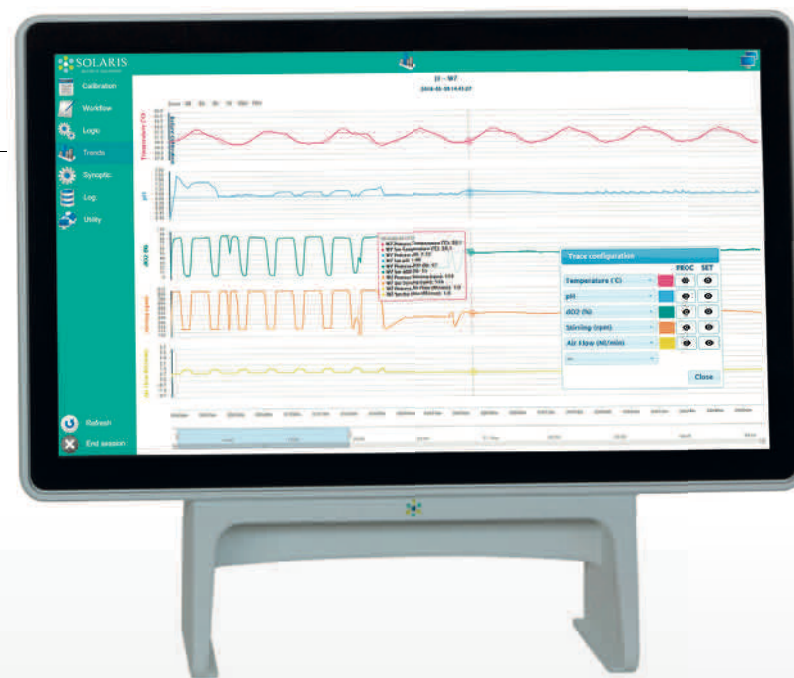
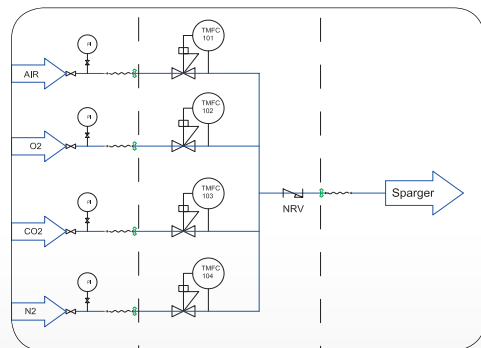

24" touch HMI

Remote access via PC, tablet/smartphone  
Remote control for after sale assistance







## Modbus Digital sensors

### Why a digital sensor?

Digital sensors (including Cell Density products) have been integrated to the Solaris PCS and Leonardo controlling software, giving the user many benefits over traditional analog sensor outputs. Such benefits include a robust communication protocol not susceptible to signal loss, in-software sensor diagnostic information, parallel calibration/batch calibrations and more.

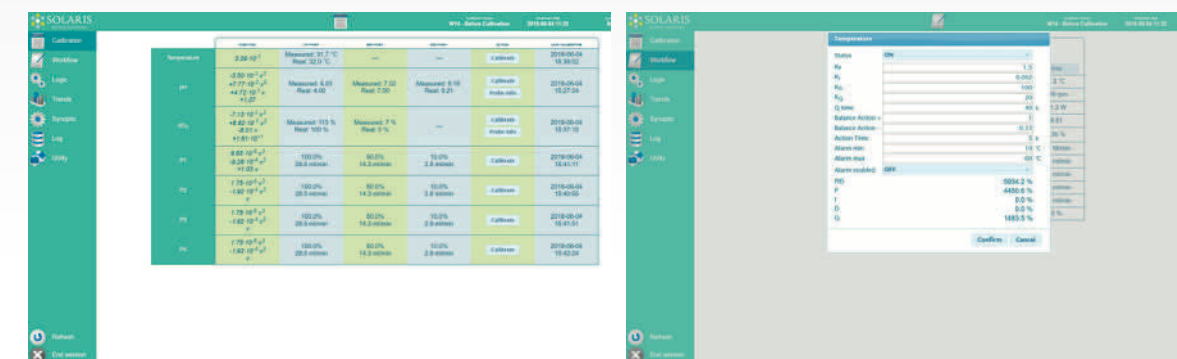

**Sensor life traceability**

**Reducing background noise**

## GAS MIXING

Hardware and software adaptability are key to enable the best aeration strategy for each process. Thermal mass flow controllers (TMFC) allow precise flow rate control of individual gasses. Up to 5 TMFC's can be configured within each PCS cube and integrated to the controlling software. The powerful software and control platform allows precise cascade adjustment of multiple parameters to manage gas transfer, OTR, kLa, etc.

- n.1 TMFC included in "entry" level system; additional available as optional.
- Various agitator and baffle designs available
- Automatic gas mixing algorithms
- Toro, sintered and other spargers available





## LEDA sterile sampling system

### Technical specifications

Material	VALOX resin (external) silicone (internal)
Autoclavable	121-133°C (up to 30 minutes)
Residual volume	0.04 mL
Flow rate	165 mL/minute

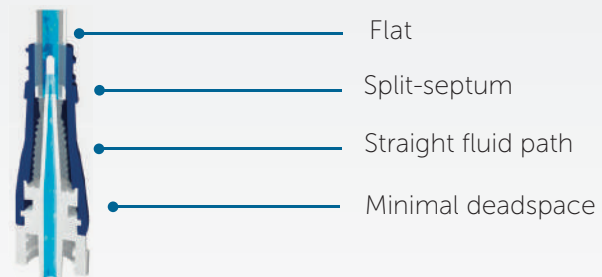

- Sterile single use sampling system up to 180 sterile sampling per batch.
- Needlefree connector is designed to reduce the risk of contamination during sampling.
- The sterile combination of a syringe (3-5-10-30 ml) and a non return valve guarantees the sterility after sampling until the next use

## Smart PCS



Solaris new modular product design strategy decreases time to market and the number of unique parts in the product architecture, increasing the number of product variants. The result is a lean, flexible and smart PCS, which can be stacked in case of parallel processes through a dedicated support.



Additional parameters in modular external boxes for future PCS upgrade including dCO<sub>2</sub>, Cell Density, Weight, Peristaltic pumps, ect.



## Leonardo 3.0

### USER-FRIENDLY SOFTWARE

Solaris controlling software offers a simply laid out, yet powerful platform for experimental design planning and process control. The graphical user interface enables the intuitive selection and adjustment of control functions. Extracted data is compatible with Window Excel but, in addition, Solaris offers a platform where fermentation data can be easily exported in real time and thus managed. This software is included in the supply and can be installed on an unlimited number of the client's PC or laptops.

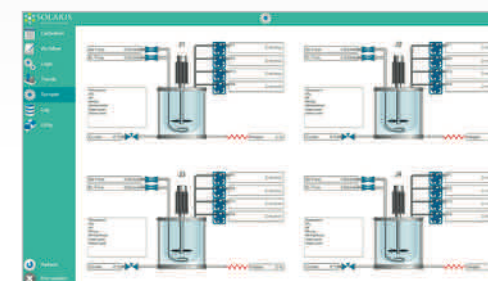

### Do it parallel: smarter..faster

Leonardo allows intuitive and time-saving parallel operations. Up to 24 independent fermentations/cultivations can be carried out simultaneously.

Parallel synoptic.

### Do it wireless!

Increase mobility: users have the option to access the platform remotely, via PC, tablet, phone. Remote access is multi-level password protected.

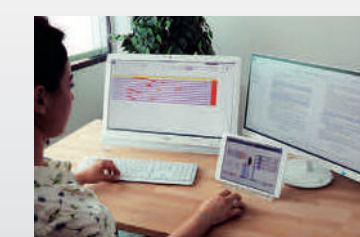
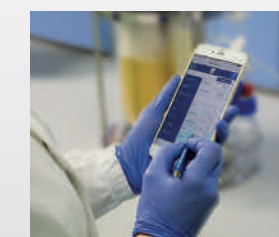

## Data sheet

Vessel					
Solaris Code	Jupiter 2.0	Jupiter 4.0	Jupiter 6.5	Jupiter 8.0	Jupiter 10.0
Production Code	jpt110300	jpt130395	jpt160395	jpt160480	jpt180480
Total Volume (L)	2,00	4,00	6,50	8,00	10,00
Ratio D/H	1:3,0	1:3,0	1:2,5	1:3,0	1:3,0
Min. Working Volume (L)	0,35	0,60	1,10	1,10	1,60
Max. Working Volume (L)	140	2,80	4,50	5,50	7,0
Max. temperature	70°C				
Operating pressure	< 0.5 bar				
Headplate Ports (n.10 in Jupiter 2.0; n.13 in the others)	10: n.1 Agitation Group, n.1 Gas Sparger, n.1 Gas Overlay, n.1 Gas Out/Condenser, n.1 Sampling/Harvesting, n.1 Temperature, n.1 Multifeed, n.2 Sensors DN12, n.1 Spare. 13: n.1 Agitation Group, n.1 Gas Sparger, n.1 Gas Overlay, n.1 Gas Out/Condenser, n.1 Sampling/Harvesting, n.1 Sterile Sampling System, n.1 Temperature, n.1 Multifeed, n.2 Sensors DN12, n.3 Spare.				
Design	Borosilicate Glass Jacketed Vessel				
Materials	Borosilicate Glass and AISI 316 L				
Sensors length (mm)					
pH	325	425	425	425	425
dO <sub>2</sub>	325	425	425	425	425
Dimensions for autoclave (with Condenser)					
Height (mm)	610	705	705	790	790
Diameter (mm)	275	285	315	315	335
Stirring					
Drive	Brushless Motor				
Speed (rpm)	1-1900	1-1800	1-1700	1-1700	1-1700
Nominal Torque (Nm)	0,9	0,9	0,9	1,1	1,1
Impellers	Select from: Rushtons impellers, Marine Impellers, Pitched blade				
Thermoregulation					
Control	PID Control - Accuracy 0,1 °C - Jacketed with n. 2 Electric Cartridge Heaters and cooling valve				
Total Heater Power (W)	400	600	700	700	700
Gas Control & Gas Mixing					
Sparger and overlay Gas Control	TMFC				
Gas Mixing (Air,CO <sub>2</sub> ,O <sub>2</sub> ,N <sub>2</sub> )	n.1 TMFC (included in entry level) + n.4 solenoid valves or + n. of additional TMFC (up to n.4)				
Sparger type	Select from: Toro type (ring), sintered microbubbling - both provided with 0,22 µm sintered filter				
Gas Out	n. 1 Condenser + 0,22 µm sinterized filter				
Peristaltic Pumps					
	n.4 Watson Marlow type 114, fixed speed, max. 60 rpm, volumetric flow 0,5-51 ml/min, function assignable from software				
	(optional) Watson Marlow type 313 FDM/D, max. speed 350 rpm, volumetric flow 1,5-1750 ml/min, function assignable from software				
Controller					
Master Control Module	From 1 to 24 units - 35x37x36 cm				
HMI with Leonardo software	Operate interface 58x15x48 cm with 24" monitor				

## Controls

INTEGRATED IN THE PCS	Temperature	
	Sensor	PT100
	Accuracy	0,1 °C
	Control system	Measuring resident in Leonardo 3.0 software
	Control range	0 - 70°C
	pH	
	Sensor	Digital sensor
	Sensitivity	57 to 59 mV/pH
	Control system	Measuring resident in Leonardo 3.0 software
	Control range	0 - 14
Operation temperature	0 - 130°C	
Pressure range	0 - 6 bar	
INTEGRATED IN THE PCS	dO <sub>2</sub>	
	Sensor	Digital Optical sensor
	Accuracy	±0.05%-vol, 21±0.2%-vol, 50±0.5%-vol
	Control system	Measuring resident in Leonardo 3.0 software
	Control range	0,05 - 300% air saturation
	Operation temperature	-10 - 130°C
	Pressure range	0 - 12 bar
	Antifoam/Level	
	Sensor	Solaris sensor
	Control	Measuring resident in Leonardo 3.0 software
INTEGRATED IN THE PCS	Redox (ORP)	
	Sensor	Digital sensor
	Sensitivity	57 to 59 mV/pH
	Control system	Measuring resident in Leonardo 3.0 software
	Control range	±2000 mV
	Operation temperature	-10 -130°C
	Pressure range	≤ 6 bar
	Conductivity	
	Sensor	Digital sensor
	Accuracy	±3%
Control system	Measuring resident in Leonardo 3.0 software	
Control range	1 - 3000 µS/cm	
Operation temperature	0 -130°C	
Pressure range	0 - 20 bar	
EXTERNAL MODULAR BOX	dCO <sub>2</sub>	
	Sensor	Analog sensor
	Accuracy	±10% (pCO <sub>2</sub> 10-900 mbar) ≥ ±10%(pCO <sub>2</sub> > 900 mbar))
	Control system	Measuring resident in Leonardo 3.0 software
	Control range	0,00-200% saturation
	Operation temperature	-20,0-150°C
	Cell density	
	Sensor	Digital sensor
	Accuracy	Mammalian cells in suspension ±5·10 <sup>4</sup> cells/ml - Fermentation ±0.05 g/l dry weight
	Control system	Measuring resident in Leonardo 3.0 software
Pressure range	0-3 bar (option 1) 0-10 bar (option 2)	
Operation temperature	0-60°C (option 1) 0-80°C (option 2) (max. sterilization temperature 135°C)	
Option 1	Dencytee: Total cell density based on turbidity (Two ranges: 10 <sup>4</sup> 5 to 10 <sup>8</sup> mammalian cells/ml - 0.5 to 100 g/L dry weight)	
Option 2	Incyte: Viable cell density based on capacitance (Two ranges: 5x10 <sup>4</sup> 5 to 8x10 <sup>8</sup> mammalian cells/ml - 5 to 200 g/L dry weight)	
Weight		
Sensor	Digital balance	
Accuracy	±0.2 g	
Control	Measuring resident in Leonardo 3.0 software	
Peristaltic pumps		
WM 114	10-60 rpm	

## Chiller

- Optionally JUPITER can be equipped with a chiller for heat removal from your culture minimizing lab water usage
- Using this system you don't need a water supply line in your lab
- Cost-effective cooling of fermenters
- Easy operation
- Refregerant level monitoring



Chiller data sheet	
Working temperature range	-10°C / +40°C
Temperature stability	±0.5
Power consumption	0.7 kW
Filling volume range	2-8 L
Cooling output at 20°C measured with ethanol	0.25-0.60 kW
Cooling output at 10°C measured with ethanol	0.20-0.50 kW
Cooling output at 0°C measured with ethanol	0.15-0.36 kW
Cooling output at -10°C measured with ethanol	0.09-0.15 kW
Pump pressure max.	0.35-1.30 bar
Pump flow max.	16-35 L/min.



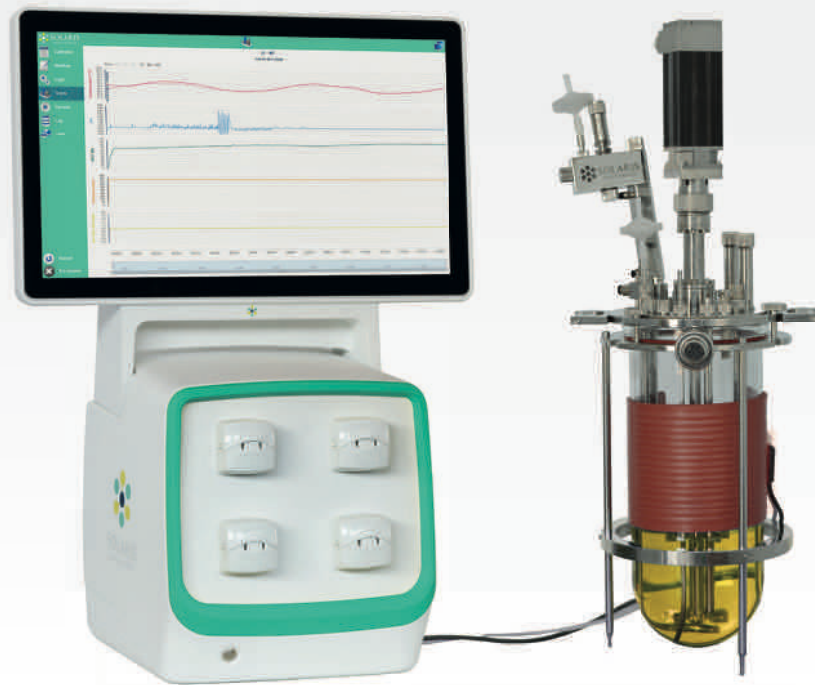

## Data sheet

Vessel					
Solaris Code	Jupiter SW 2.0	Jupiter SW 4.0	Jupiter SW 6.5	Jupiter SW 8.0	Jupiter SW 10.0
Production Code	L110300	L130395	L160395	L160480	L180480
Total Volume (L)	2,00	4,00	6,50	8,00	10,00
Ratio D/H	1:3,0	1:3,25	1:2,50	1:3,20	1:3,0
Min. Working Volume (L)	0,35	0,60	1,10	1,10	1,60
Max. Working Volume (L)	1,40	2,80	4,50	5,50	7,0
Max. temperature	70°C				
Operating pressure	< 0,5 bar				
Headplate Ports (n.10 in Jupiter 2.0; n.13 in the others)	10: n. 1 Agitation Group, n.1 Gas Sparger, n.1 Gas Overlay, n.1 Gas Out/Condenser, n.1 Sampling/Harvesting, n.1 Temperature, n.1 Multifeed, n.2 Sensors DN12, n.1 Cooling Finger. 13: n.1 Agitation Group, n.1 Gas Sparger, n.1 Gas Overlay, n.1 Gas Out/Condenser, n.1 Sampling/Harvesting, n.1 Sterile Sampling System, n.1 Temperature, n.1 Multifeed, n.2 Sensors DN12, n.1 Cooling Finger, n.2 Spare.				
Design	Borosilicate Glass Vessel				
Materials	Borosilicate Glass and AISI 316 L				
Sensors length (mm)					
pH	325	425	425	425	425
dO <sub>2</sub>	325	425	425	425	425
Dimensions for autoclave (with Condenser)					
Height (mm)	610	705	705	790	790
Diameter (mm)	275	285	315	315	335
Stirring					
Drive	Brushless Motor				
Speed (rpm)	1-1900	1-1800	1-1700	1-1700	1-1700
Nominal Torque (Nm)	0,9	0,9	0,9	1,1	1,1
Impellers	Select from: Rushtons impellers, Marine Impellers, Pitched blade				
Thermoregulation					
Control	PID Control - Accuracy 0,1 °C - n. 1 Electric Heating Blanket, n.1 cooling finger				
Total Heater Power (W)	100	125	125	160	180
Gas Control & Gas Mixing					
Sparger and overlay Gas Control	TMFC				
Gas Mixing (Air,CO <sub>2</sub> ,O <sub>2</sub> ,N <sub>2</sub> )	n.1 TMFC (included in entry level) + n.4 solenoid valves or + n. of additional TMFC (up to n.4)				
Sparger type	Select from: Toro type (ring), sintered microbubbling - both provided with 0,22 µm sintered filter				
Gas Out	n. 1 Condenser + 0,22 µm sinterized filter				
Peristaltic Pumps					
	n.4 Watson Marlow type 114, fixed speed, max. 60 rpm, volumetric flow 0,5-51 ml/min, function assignable from software				
	(optional) Watson Marlow type 313 FDM/D, max. speed 350 rpm, volumetric flow 1,5-1750 ml/min, function assignable from software				
Controller					
Master Control Module	From 1 to 24 units - 35x37xh36 cm				
HMI with Leonardo software	Operate interface 58x15xh48 cm with 24" monitor				

# AUTOCLAVABLE PRESSURE CONTROLLED FERMENTERS/BIOREACTORS

## VENUS

In addition to control parameters available in standard benchtop systems, the **Venus** platform offers the additional capability of Pressure Control.

In many fermentation product development cycles, over pressurization control is enabled only at pilot plant scales. Utilizing pressure control at the benchtop scale allows this parameter to be studied and better optimized, aiding considerations to gas mass transfer management when scaling up.

Venus greatly adds efficiency to the appropriate product development application.

**VENUS** typical applications includes the following:

- Education & Basic research
- Scale-up and scale-down studies
- Process development and optimization

**VENUS** can be used for:

- Biopharmaceutical
- Biofuels
- Food industry
- Bioremediation
- Bioplastic
- Cosmeceutical
- Nutraceutical



Pressure  
controlled  
up to 2 bar

**WHY TO  
INVEST**  
IN THIS PRODUCT

Removable jacket  
before autoclaving:  
**Lighter & Handling**  
**Improved heat  
transfer**

Higher oxygen  
transfer



## Benefits

Up to 24 units managed with one HMI with innovative **PARALLEL process control**

LEONARDO: smart controller designed to provide a high level of automated management of the fermentation/cultivation processes

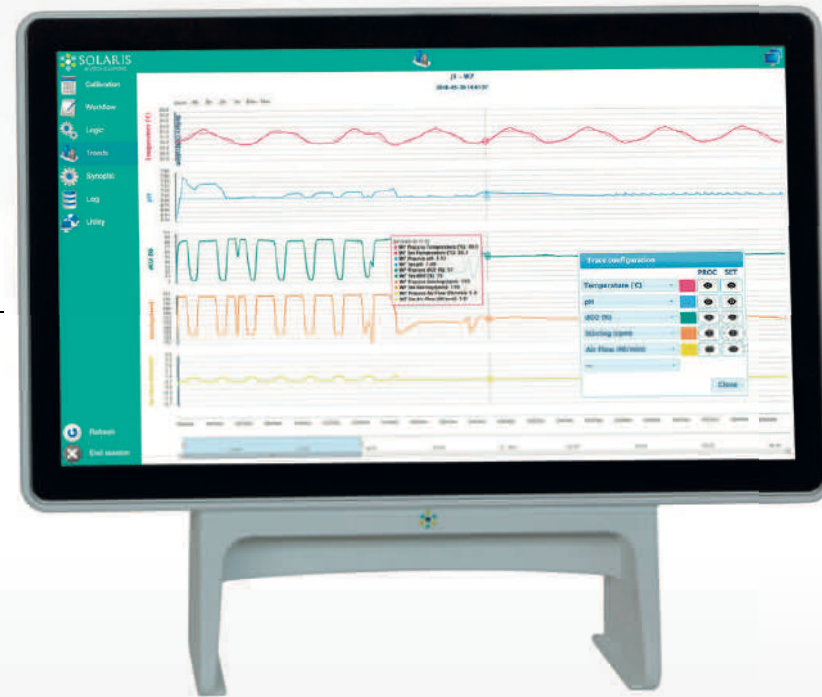

24" touch HMI

Batch, Fed batch or continuous processes

Different gas mixing strategies with up to 5 TMFC

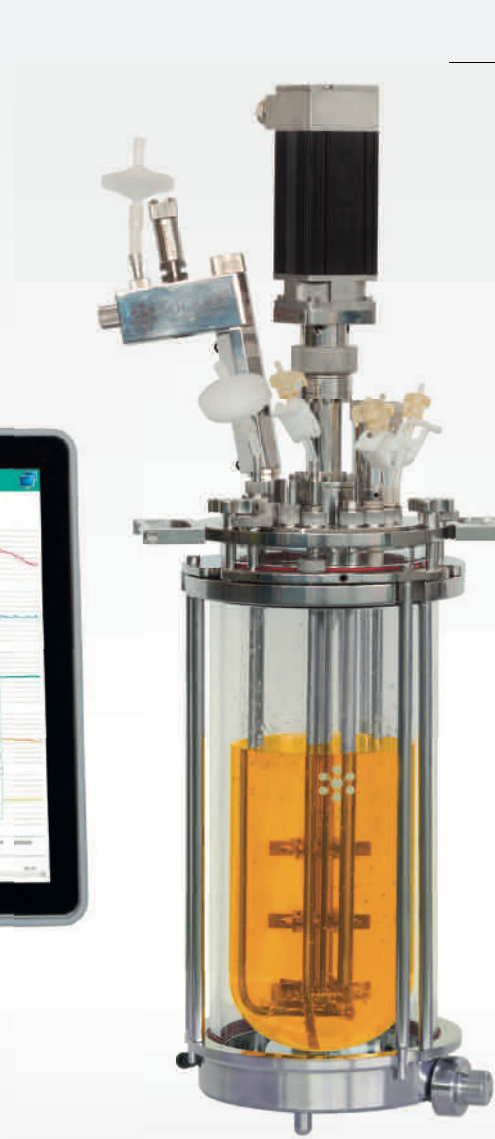
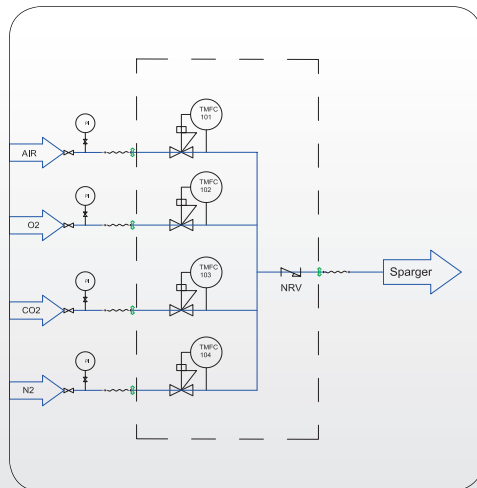

Powerful/ Accurate **brushless motor**, from 1 to 2000 RPM. Online absorbed Torques (Nm) and Power (W) measurements obtaining an indirect density indication of the culture broth

Modbus Digital sensors



Compact and modular PCS

N.4 assignable Watson Marlow pumps in entry level

Fully **removable and cleanable glass jacket** for an improved heat transfer during autoclaving

**Pressure controlled up to 2 bar**  
**Easier scaling up**  
**Higher oxygen transfer**



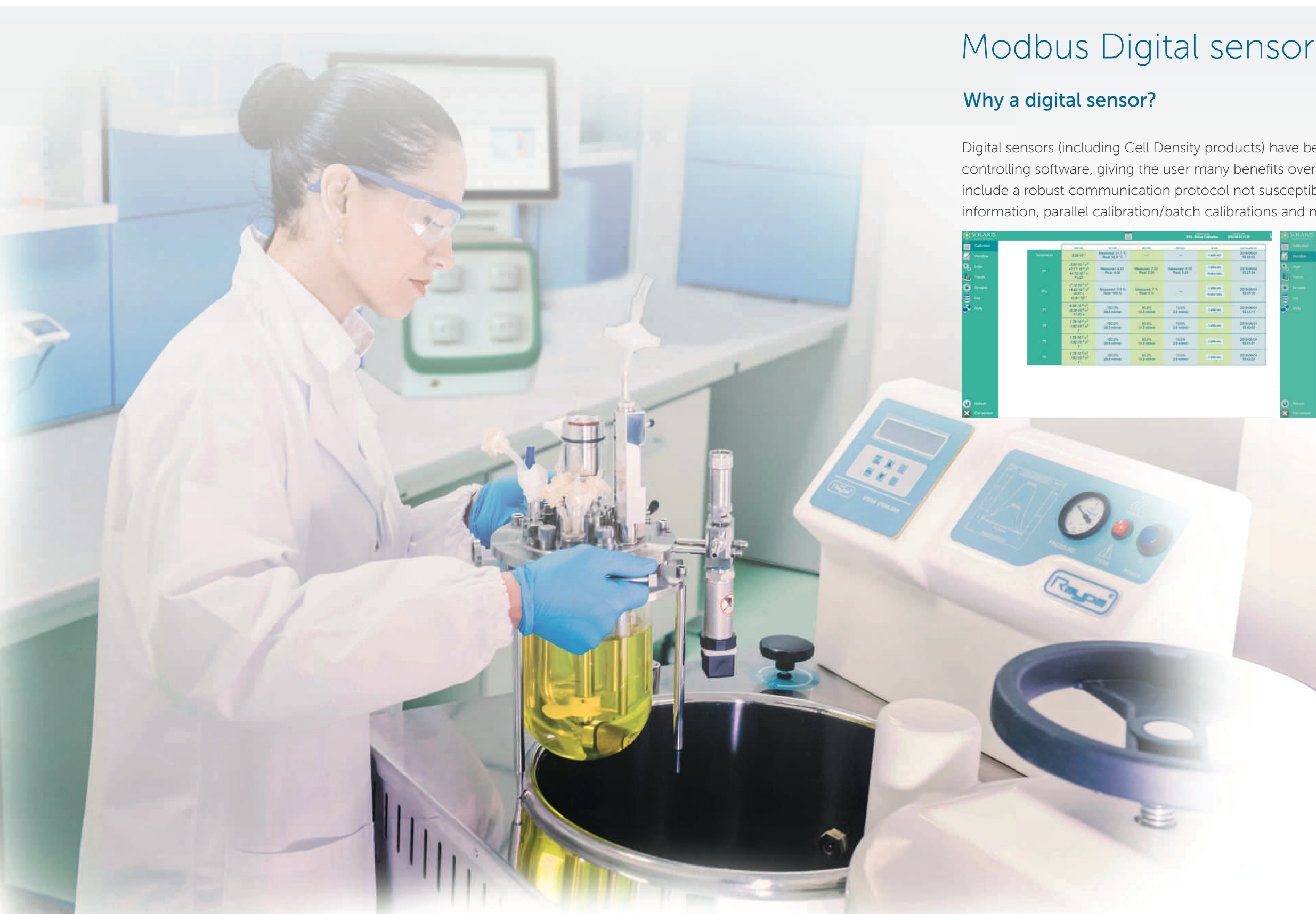

## Modbus Digital sensors

### Why a digital sensor?

Digital sensors (including Cell Density products) have been integrated to the Solaris PCS and Leonardo controlling software, giving the user many benefits over traditional analog sensor outputs. Such benefits include a robust communication protocol not susceptible to signal loss, in-software sensor diagnostic information, parallel calibration/batch calibrations and more.

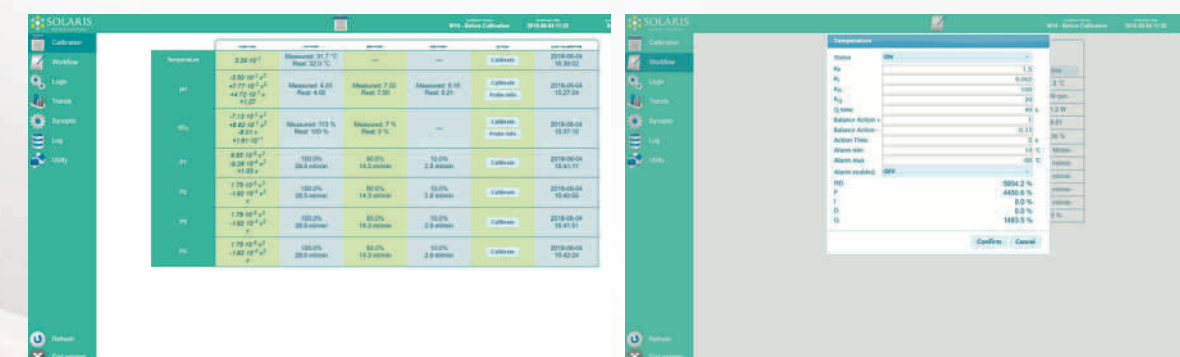

Sensor life traceability

Reducing background noise

### GAS MIXING

Hardware and software adaptability are key to enable the best aeration strategy for each process. Thermal mass flow controllers (TMFC) allow precise flow rate control of individual gasses. Up to 5 TMFC's can be configured within each PCS cube and integrated to the controlling software. The powerful software and control platform allows precise cascade adjustment of multiple parameters to manage gas transfer, OTR, KLa, etc.

- n.1 TMFC included in "entry" level system; additional available as optional.
- Various agitator and baffle designs available
- Automatic gas mixing algorithms
- Toro, sintered and other spargers available





## Leonardo 3.0 USER-FRIENDLY SOFTWARE



Solaris controlling software offers a simply laid out, yet powerful platform for experimental design planning and process control. The graphical user interface enables the intuitive selection and adjustment of control functions. Extracted data is compatible with Window Excel but, in addition, Solaris offers a platform where fermentation data can be easily exported in real time and thus managed. This software is included in the supply and can be installed on an unlimited number of the client's PC or laptops.

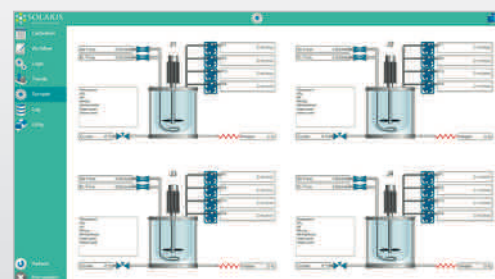

Parallel synoptic

### Do it parallel: smarter..faster

Leonardo allows intuitive and time-saving parallel operations. Up to 24 independent fermentations/cultivations can be carried out simultaneously.

## Leonardo 3.0

### Do it wireless!

Increase mobility: users have the option to access the platform remotely via PC, tablet, phone. Remote access is multi-level password protected.

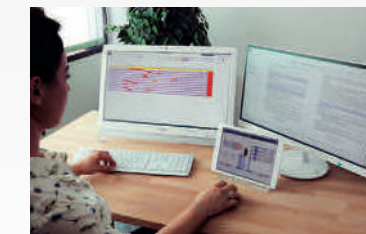

### Smart PCS



Solaris new modular product design strategy decreases time to market and the number of unique parts in the product architecture, increasing the number of product variants. The result is a lean, flexible and smart PCS, which can be stacked in case of parallel processes through a dedicated support.



Additional parameters in modular external boxes for future PCS upgrade including dCO<sub>2</sub>, Cell Density, Weight, Peristaltic pumps, ect.



## Data sheet

Vessel		
Solaris Code	Venus 2.0	Venus 4.0
Production Code	vns110300	vns130395
Total Volume (liters)	2,00	4,00
Ratio D/H	1:3,0	1:3,25
Min. Working Volume (liters)	0,35	0,60
Max. Working Volume (liters)	1,40	2,80
Max. temperature	70°C	
Operating pressure	1.6 bar	1.6 bar
Headplate Ports (n.10 Venus 2.0; n.13 Venus 4.0)	Venus 2.0: n.1 Agitation Group, n.1 Gas Sparger, n.1 Gas Overlay, n.1 Gas Out/Condenser, n.1 Sampling/Harvesting, n.1 Temperature, n.1 Multifeed, n.2 Sensors DN12, n.1 Spare Venus 4.0: n.1 Agitation Group, n.1 Gas Sparger, n.1 Gas Overlay, n.1 Gas Out/Condenser, n.1 Sampling, n.1 Harvesting, n.1 Temperature, n.1 Multifeed, n.2 Sensors DN12, n.3 Spare.	
Design	Borosilicate Glass Jacketed Vessel	
Materials	Borosilicate Glass and AISI 316 L	
pH	325	425
dO <sub>2</sub>	325	425
Dimensions for autoclave (with Condenser)		
Height (mm)	619	705
Diameter (mm)	275	285
Stirring		
Drive	Brushless Motor	
Speed (rpm)	1-1900	1-1800
Nominal torque (Nm)	0,9	0,9
Impellers	Select from: Rushtons impellers, Marine Impellers, Pitched blade	
Thermoregulation		
Control	PID Control - Accuracy 0,1 °C - Jacketed with n. 2 Electric Cartridge Heaters	
Total Heater Power (W)	400	600
Gas Control & Gas Mixing		
Sparger and overlay Gas Control	TMFC with 0,22 µm sinterized filter	
Gas Mixing (Air, CO <sub>2</sub> , O <sub>2</sub> , N <sub>2</sub> )	n. 1 TMFC (included in entry level)+ n.4 solenoid valves or + n. of additional TMFC (up to 4)	
Sparger type	Select from: Toro type (ring), sintered microbubbling both provided with 0,2 µm filter	
Exhaust	Condenser and 0,22 µm filter	
Peristaltic Pumps		
	n.4 Watson Marlow type 114, fixed speed, max. 60 rpm, volumetric flow 0,5-51 ml/min, function assignable from software	
	(optional) Watson Marlow type 313 FDM/D, max. speed 350 rpm, volumetric flow 1,5-1750 ml/min, function assignable from software	
Controller		
Master Control Module	From 1 to 24 units - 35x37xh36 cm	
HMI with Leonardo software	Operate interface 58x15xh48 cm with 24" monitor	

## Controls

INTEGRATED IN THE PCS	Temperature	
	Sensor	PT100
	Accuracy	0,1 °C
	Control system	Measuring resident in Leonardo 3.0 software
	Control range	0 - 70°C
	pH	
	Sensor	Digital sensor
	Sensitivity	57 to 59 mV/pH
	Control system	Measuring resident in Leonardo 3.0 software
	Control range	0 - 14
Operation temperature	0 - 130°C	
Pressure range	0 - 6 bar	
INTEGRATED IN THE PCS	dO <sub>2</sub>	
	Sensor	Digital Optical sensor
	Accuracy	±0.05%-vol, 21±0.2%-vol, 50±0.5%-vol
	Control system	Measuring resident in Leonardo 3.0 software
	Control range	0,05 - 300% air saturation
	Operation temperature	-10 - 130°C
	Pressure range	0 - 12 bar
	Antifoam/Level	
	Sensor	Solaris sensor
	Control	Measuring resident in Leonardo 3.0 software
INTEGRATED IN THE PCS	Redox (ORP)	
	Sensor	Digital sensor
	Sensitivity	57 to 59 mV/pH
	Control system	Measuring resident in Leonardo 3.0 software
	Control range	±2000 mV
	Operation temperature	- 10 -130°C
	Pressure range	< 6 bar
	Conductivity	
	Sensor	Digital sensor
	Accuracy	±3%
Control system	Measuring resident in Leonardo 3.0 software	
Control range	1 - 3000 µS/cm	
Operation temperature	0 -130°C	
Pressure range	0 - 20 bar	
INTEGRATED IN THE PCS	dCO <sub>2</sub>	
	Sensor	Analog sensor
	Accuracy	±10% (pCO <sub>2</sub> 10-900 mbar) ≥ ±10%(pCO <sub>2</sub> > 900 mbar))
	Control system	Measuring resident in Leonardo 3.0 software
	Control range	0,00-200% saturation
	Operation temperature	-20,0-150°C
	Cell density	
	Sensor	Digital sensor
	Accuracy	Mammalian cells in suspension ±5·10 <sup>4</sup> cells/ml - Fermentation ±0.05 g/l dry weight
	Control system	Measuring resident in Leonardo 3.0 software
Pressure range	0-3 bar (option 1) 0-10 bar (option 2)	
Operation temperature	0-60°C (option 1 ) 0-80°C (option 2 ) (max. sterilization temperature 135°C)	
Option 1	Dencytee: Total cell density based on turbidity (Two ranges: 10 <sup>5</sup> to 10 <sup>8</sup> mammalian cells/ml - 0.5 to 100 g/L dry weight)	
Option 2	Incyte: Viable cell density based on capacitance (Two ranges: 5x10 <sup>5</sup> to 8x10 <sup>8</sup> mammalian cells/ml - 5 to 200 g/L dry weight)	
EXTERNAL MODULAR BOX	Weight	
	Sensor	Digital Balance
	Accuracy	±0.2 g
	Control	Measuring resident in Leonardo 2.0 software
	Peristaltic pumps	
	WM 114	10-60 rpm

## Chiller

- Optionally VENUS can be equipped with a chiller for heat removal from your culture minimizing lab water usage
- Using this system you don't need a water supply line in your lab
- Cost-effective cooling of fermenters
- Easy operation
- Refrigerant level monitoring



### Chiller data sheet

Working temperature range	-10°C / +40°C
Temperature stability	±0.5
Power consumption	0.7 kW
Filling volume range	2-8 L
Cooling output at 20°C measured with ethanol	0.25-0.60 kW
Cooling output at 10°C measured with ethanol	0.20-0.50 kW
Cooling output at 0°C measured with ethanol	0.15-0.36 kW
Cooling output at -10°C measured with ethanol	0.09-0.15 kW
Pump pressure max.	0.35-1.30 bar
Pump flow max.	16-35 L/min.



# STIRRED AUTOCLAVABLE PHOTOBIOREACTORS

## ELARA ST

ELARA ST photobioreactor series is ideal for phototrophic organisms such as moss, microalgae, bacteria and plant cells. The light spectrum and intensity is adjustable 0-100% up to 3000  $\mu\text{mol}(\text{photon})/\text{m}^2$ .

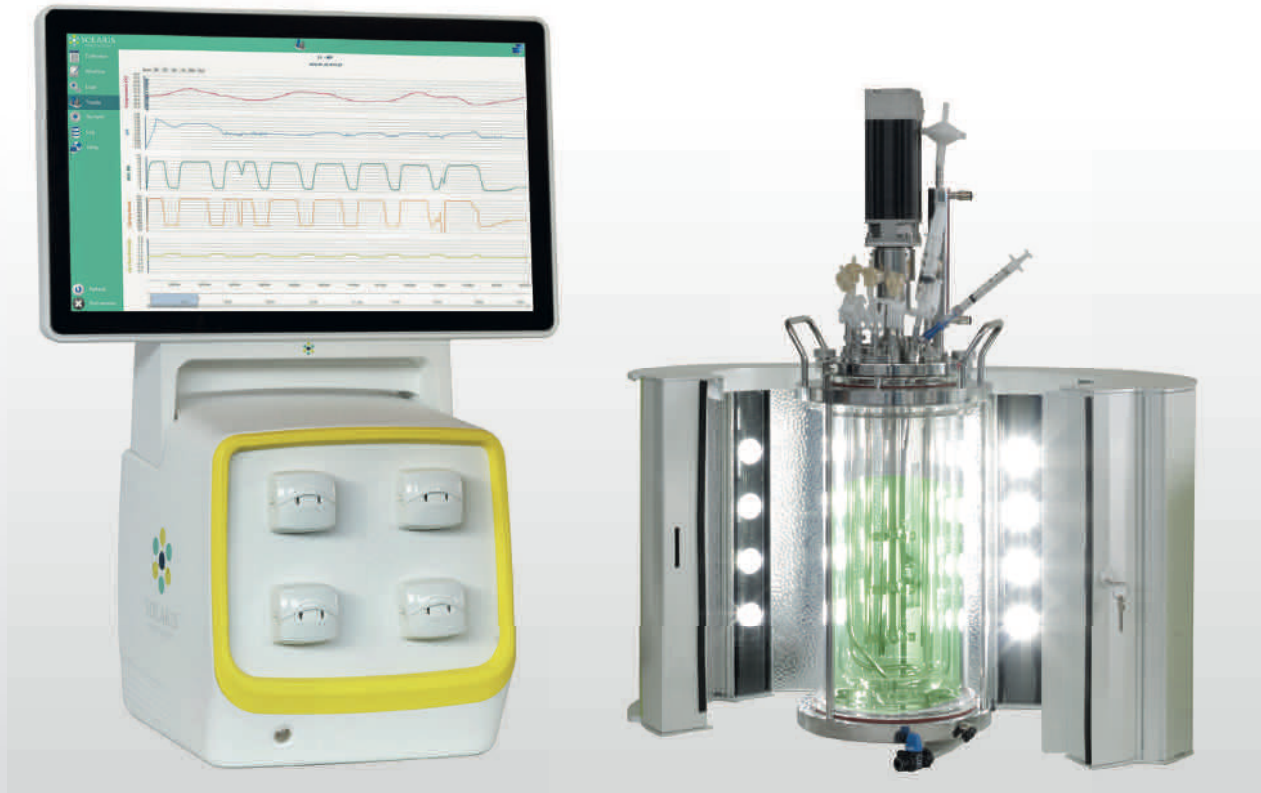

ELARA ST typical applications includes the following:

- Education & Basic research
- Scale-up and scale-down studies
- Process development and optimization

ELARA ST can be used for:

- Algae
- Phototrophic bacteria
- Plant cells

**INNOVATIVE  
SOLUTION**  
to improve your  
microalgae culture

**WHY TO  
INVEST**  
IN THIS PRODUCT

High power  
**LED lighting**,  
spectrum selectable  
and  
dimnable 0-100%

**FLEXIBILITY**

The fully removable light  
module allows to use Elara  
as a traditional fermenter

## Benefits

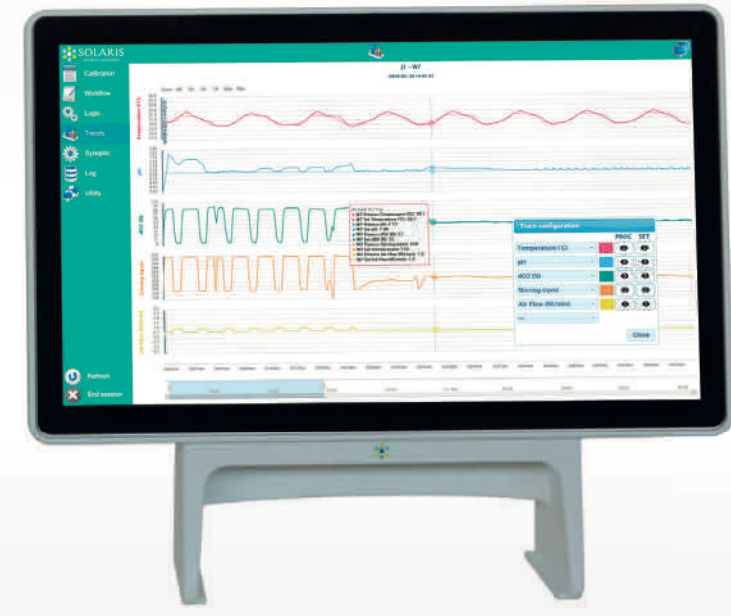
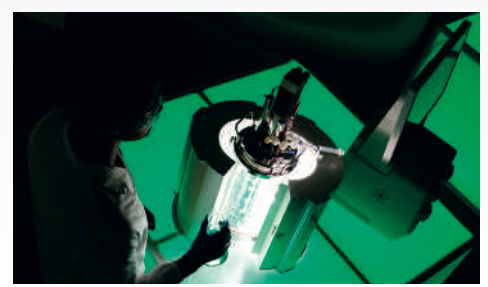
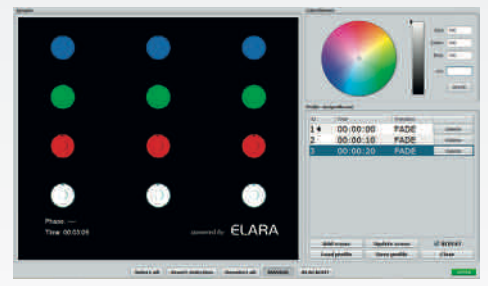

Different gas mixing strategies with up to 5 TMFC

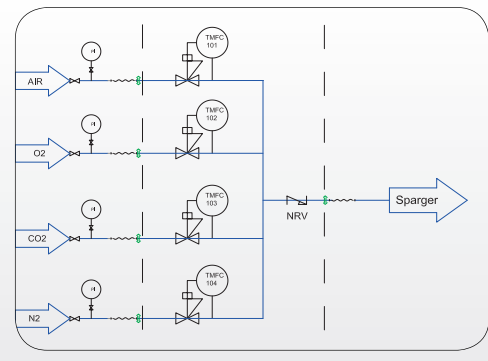

24" touch HMI.



Automatic and manual control of RBW light intensity and circadian cycle simulation

Powerful/ Accurate **brushless motor**, from 1 to 2000 RPM. Online absorbed Torques (Nm) and Power (W) measurements obtaining an indirect density indication of the culture broth.

Modbus Digital sensors



LEDA safe sterile sampling system  
The needle free connector is designed to reduce the risk of contamination during sampling.  
The sterile combination of a syringe (3-5-10-30 ml) and a non return valve guarantees the sterility after sampling until the next use.



Safety: pressure relief valve included in each unit.

Compact and modular PCS

N.4 assignable Watson Marlow pumps in entry level

Additional External modular box:  
OD, dCO2, weight, thermobox, peristaltic pumps

Fully removable and cleanable jacket



## Modbus Digital sensors

### Why a digital sensor?

Digital sensors (including Cell Density products) have been integrated to the Solaris PCS and Leonardo controlling software, giving the user many benefits over traditional analog sensor outputs. Such benefits include a robust communication protocol not susceptible to signal loss, in-software sensor diagnostic information, parallel calibration/batch calibrations and more.

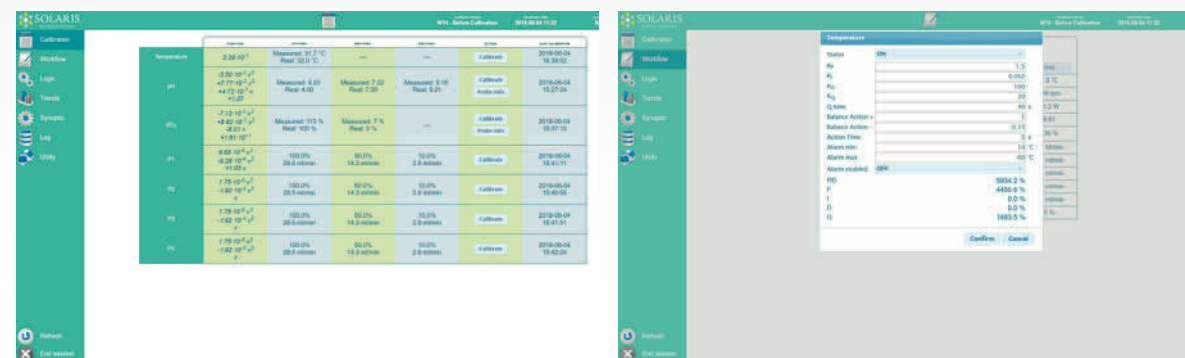

**Sensor life  
traceability**

**Reducing  
background noise**

### GAS MIXING

Hardware and software adaptability are key to enable the best aeration strategy for each process. Thermal mass flow controllers (TMFC) allow precise flow rate control of individual gasses. Up to 5 TMFC's can be configured within each PCS cube and integrated to the controlling software. The powerful software and control platform allows precise cascade adjustment of multiple parameters to manage gas transfer, OTR, kLa, etc.

- n.1 TMFC included in "entry" level system; additional available as optional.
- Various agitator and baffle designs available
- Automatic gas mixing algorithms
- Toro, sintered and other spargers available



### USER-FRIENDLY SOFTWARE

Solaris controlling software offers a simply laid out, yet powerful platform for experimental design planning and process control. The graphical user interface enables the intuitive selection and adjustment of control functions. Extracted data is compatible with Window Excel but, in addition, Solaris offers a platform where fermentation data can be easily exported in real time and thus managed. This software is included in the supply and can be installed on an unlimited number of the client's PC or laptops.



### Do it parallel: smarter..faster

Leonardo allows intuitive and time-saving parallel operations. Up to 24 independent fermentations/cultivations can be carried out simultaneously.

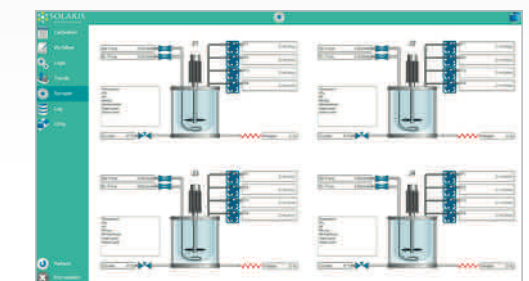

### Do it wireless!

Increase mobility: users have the option to access the platform remotely via PC, tablet, phone. Remote access is multi-level password protected.

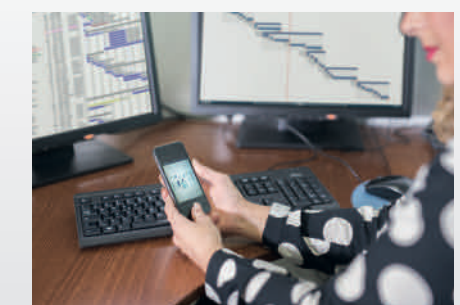

## Data sheet

Vessel	
<b>Photobioreactor type</b>	<b>Stirred</b>
Total Volume (liters)	4,00
Ratio D/H	1:3,0
Min. Working Volume (liters)	0,60
Max. Working Volume (liters)	3,00
Max. temperature	135 °C
Operating pressure	< 0,5 bar
Ports	n.1 port, Gas Sparger Input n.1 port, Gas overlay n.1 port, Gas Out n.1 port, Harvesting system n. 1 port, Sampling system n.1 port, Temperature Sensor n.1 port, multi addition (4) needle free connectors n.5 ports, spares probes n.1 port, single addition needle free connector n.1 port, Agitation Group
Design	Borosilicate Glass Jacketed Vessel
Materials	Borosilicate Glass and AISI 316 L
Sensors lenght (mm)	
pH	325
dO <sub>2</sub>	325
Dimensions for autoclave (with Condenser)	
Height (mm)	655
Diameter (mm)	225
Stirring	
Drive	Brushless Motor, Direct Assembly , 1-2000 rpm (bacterial), 1-500 (cell cultures)
Power (P <sub>N</sub> )	266 W
Impellers	Select from: Rushtons impellers, Marine Impellers, Pitched blade
Thermoregulation	
Control	PID Control - Accuracy 0,1 °C Thermobox (flat) / water jacketed with electric heaters (stirred vessel)
Gas Control & Gas Mixing	
Sparger and overlay Gas Control	TMFC
Gas Mixing (Air,CO <sub>2</sub> ,O <sub>2</sub> ,N <sub>2</sub> )	n.1 TMFC + n. solenoid valves or n° of TMFC
Aeration system	Toro ring or sintered (microbubbling) sparger with 0,2 µm filter
Exhaust	Condenser and 0,2 µm filter
Peristaltic Pumps	
	n.4 Watson Marlow type 114, fixed speed, max. 60 rpm, volumetric flow 0,5-51 ml/min, function assignable from software (optional) Watson Marlow type 313 FDM/D, max. speed 350 rpm, volumetric flow 1,5-1750 ml/min, function assignable from software
Controller	
Master Control Module	From 1 to 24 units - 35x37xh36 cm
HMI with Leonardo software	Operate interface 58x15xh48 cm with 24" monitor

## Controls

Temperature	
Sensor	PT100
Control system	Measuring resident in Leonardo 3.0 software
Control range	0 - 150°C
pH	
Sensor	Digital sensor
Control system	Measuring resident in Leonardo 3.0 software
Control range	0 - 14
Operation temperature	0 - 130°C
Pressure range	0 - 6 bar
Actuator	Cascade to peristaltic pumps for the addition of acid/base solutions or gas (CO <sub>2</sub> )
dO <sub>2</sub>	
Sensor	Digital Optical sensor
Control system	Measuring resident in Leonardo 3.0 software
Control range	0,05 - 300% air saturation
Operation temperature	-10 - 130°C
Pressure range	0 - 12 bar
Actuator	Cascade to RPM, Gas Control, feedings,ect
Antifoam/Level	
Sensor	Solaris sensor
Control	Measuring resident in Leonardo 3.0 software
Redox (ORP)	
Sensor	Digital sensor
Control system	Measuring resident in Leonardo 3.0 software
Control range	±2000 mV
Operation temperature	- 10 -130°C
Pressure range	≤ 6 bar
Conductivity	
Sensor	Digital sensor
Control system	Measuring resident in Leonardo 3.0 software
Control range	1 - 3000 µS/cm
Operation temperature	0 -130°C
dCO <sub>2</sub>	
Sensor	Analog sensor
Control system	Measuring resident in Leonardo 3.0 software
Control range	0,00-200% saturation
Operation temperature	-20,0-150°C
Pressure range	0 - 4 bar
Weight	
Sensor	Digital Balance
Control	Measuring resident in Leonardo 3.0 software
Peristaltic pumps	
WM 114	10-60 rpm
WM 313 FDM/D	45-350 rpm

## Chiller

- Optionally ELARA can be equipped with a chiller for heat removal from your culture minimizing lab water usage
- Using this system you don't need a water supply line in your lab
- Cost-effective cooling of fermenters
- Easy operation
- Refregerant level monitoring



Chiller data sheet	
Working temperature range	-10°C / +40°C
Temperature stability	±0.5
Power consumption	0.7 kW
Filling volume range	2-8 L
Cooling output at 20°C measured with ethanol	0.25-0.60 kW
Cooling output at 10°C measured with ethanol	0.20-0.50 kW
Cooling output at 0°C measured with ethanol	0.15-0.36 kW
Cooling output at -10°C measured with ethanol	0.09-0.15 kW
Pump pressure max.	0.35-1.30 bar
Pump flow max.	16-35 L/min.



# PHOTOBIOREACTORS

## ELARA FLAT

**INNOVATIVE SOLUTION  
TO IMPROVE MICROALGAE CULTURE**

**ELARA Flat** photobioreactor is ideal for phototrophic organisms as moss, microalgae, bacteria and plant cells. The flat design allows much better light intensity control by utilizing a uni-directional light source and receiver. The light intensity is dimmable from 0-100% up to 3000  $\mu\text{mol}(\text{photon})/\text{m}^2$ .

**ELARA Flat** typical applications includes the following:  
Education & Basic research  
Scale-up and scale-down studies  
Process development and optimization

**ELARA Flat** can be used for:  
Algae  
Phototrophic bacteria  
Plant cells

**Homogeneous  
Light distribution**

**High power  
LED lighting,  
spectrum selectable  
and  
dimmable 0-100%**

**Highly resistant  
to  
salty water**

**WHY TO  
INVEST  
IN THIS PRODUCT**

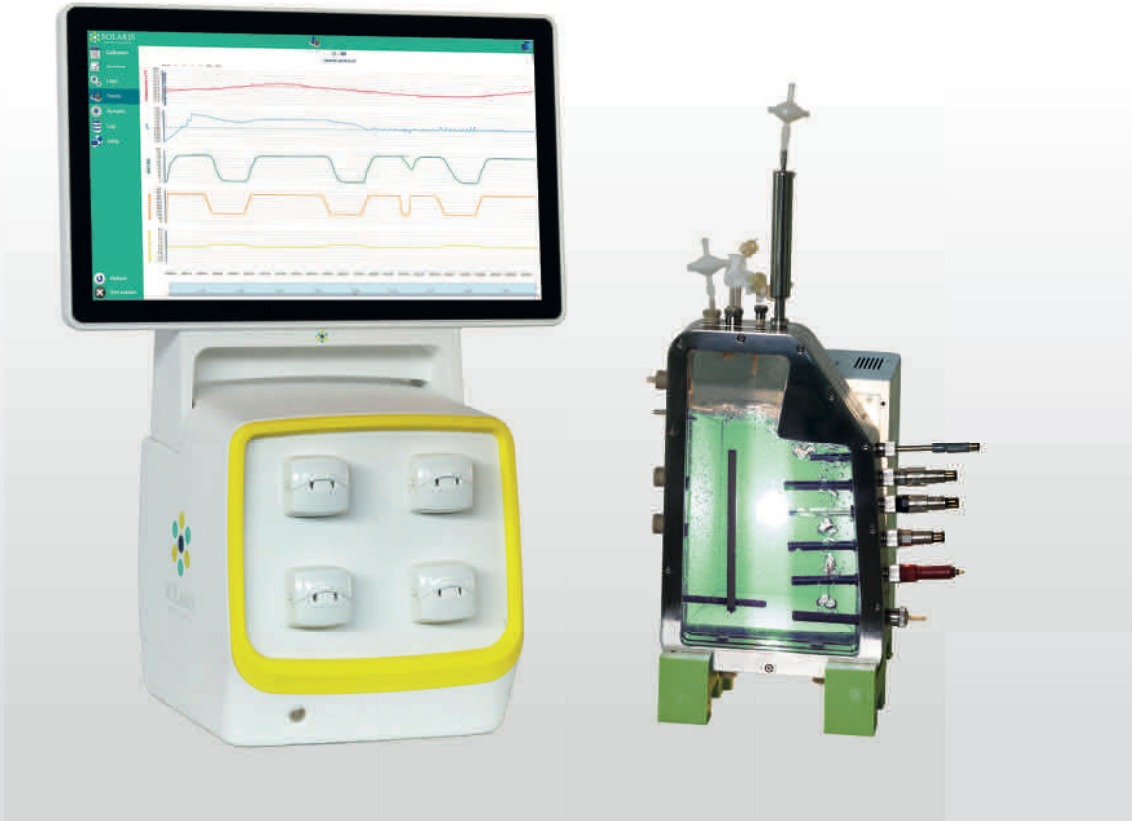

# PHOTOBIOREACTORS

## Benefits

Up to 24 units managed with one HMI with innovative PARALLEL process control LEONARDO: smart controller designed to provide an high level of automated management of the fermentation/ cultivation processes  
Batch, Fed batch or continuous processes

Assymetric shape to prevent foam formation

Homogeneous light distribution  
Automatic and manual control of light intensity and circadian cycle simulation

Modbus Digital sensors

Safety: pressure relief valve included in each unit.

Compact and modular PCS

N.4 assignable Watson Marlow pumps in entry level

Additional External modular box:  
OD, dCO<sub>2</sub>, weight, thermobox, peristaltic pumps

Parts in contact with the culture made in borosilicate glass and Super duplex SAF 2507 highly resistant to salty water

24" touch HMI.

Remote control via PC, tablet and smartphone for process management and after sale assistance

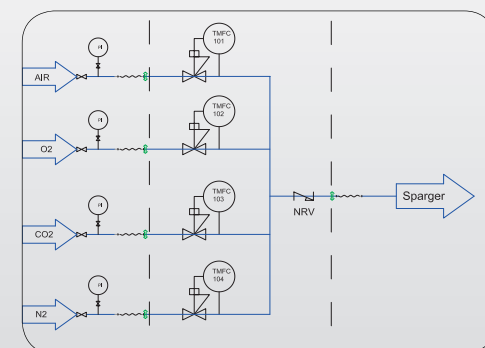
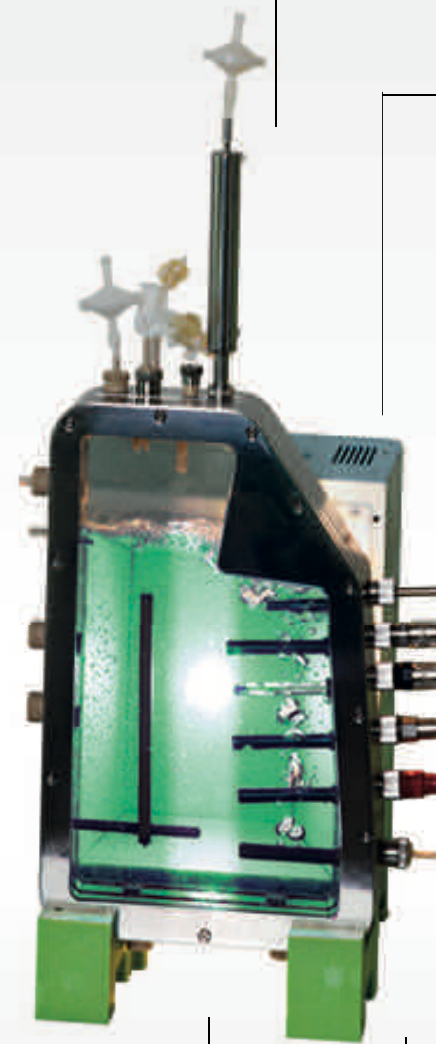
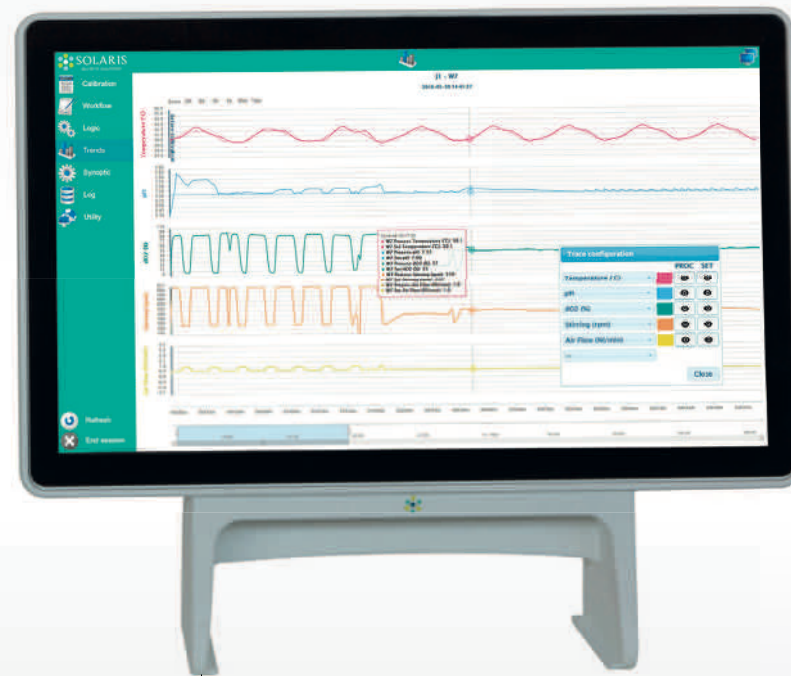
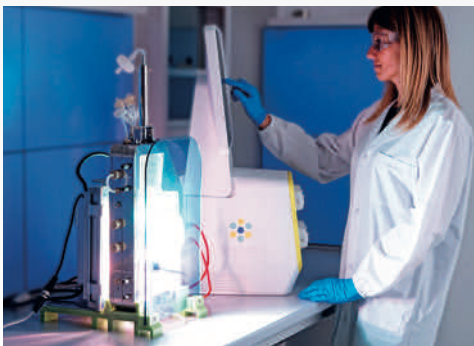

Airlift mixing process  
Different gas mixing strategies with up to 5 TMFC





## HOMOGENEOUS LIGHT DISTRIBUTION

The innovative flat design allows a homogeneous light distribution, even at high viscosity.

## MATERIAL

Parts that are product contacting are made from borosilicate glass and Super duplex SAF 2507, for compatibility with high salt concentrations.

## ASYMMETRICAL SHAPE

The asymmetrical shape is highly effective for the management of foam formation.

## MODBUS DIGITAL SENSORS

Digital sensors (including Cell Density products) have been integrated to the Solaris PCS and Leonardo controlling software, giving the user many benefits over traditional analog sensor outputs. Such benefits include a robust communication protocol not susceptible to signal loss, in-software sensor diagnostic information, parallel calibration/batch calibrations and more.

## AIRLIFT

The Flat system utilizes an airlifting design allowing gentle mixing and ensuring efficient homogenization.

## GAS MIXING

Hardware and software adaptability are key to enable the best aeration strategy for each process. Thermal mass flow controllers (TMFC) allow precise flow rate control of individual gasses. Up to 5 TMFC's can be configured within each PCS cube and integrated to the controlling software. The powerful software and control platform allows precise cascade adjustment of multiple parameters to manage gas transfer, OTR, kLa, etc.

## USER-FRIENDLY SOFTWARE

Solaris controlling software offers a simply laid out, yet powerful platform for experimental design planning and process control. The graphical user interface enables the intuitive selection and adjustment of control functions. Extracted data is compatible with Window Excel but, in addition, Solaris offers a platform where fermentation data can be easily exported in real time and thus managed. This software is included in the supply and can be installed on an unlimited number of the client's PC or laptops.



## Do it parallel: smarter..faster

Leonardo allows intuitive and time-saving parallel operations. Up to 24 independent fermentations/cultivations can be carried out simultaneously.

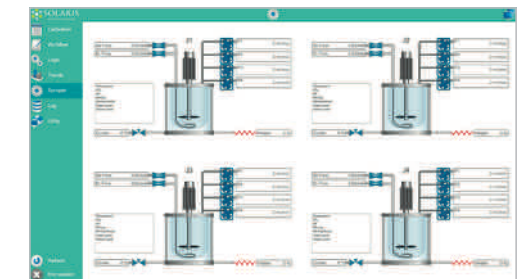

## Do it wireless!

Increase mobility: users have the option to access the platform remotely via PC, tablet, phone. Remote access is multi-level password protected.

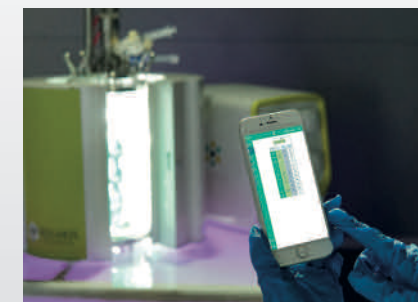
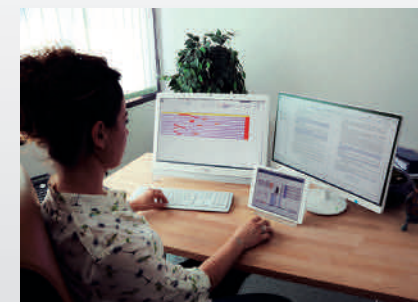

## Data sheet

Vessel	
<b>Photobioreactor type</b>	<b>Flat</b>
Total Volume (liters)	1,60
Ratio D/H	1:2,4
Min. Working Volume (liters)	1,30
Max. Working Volume (liters)	1,40
Max. temperature	50 °C
Operating pressure	< 0,5 bar
Ports	n.1 port, Gas out Condenser n.1 port, Antifoam probe n.1 port, multi addition (3) needle free connectors n.1 port, single addition needle free connector n.4 port, Hygienic Socket Solaris, Spare probes n.1 port, temp. housing, PT100 n.2 ports, Sampling system n.1 port, Gas Sparger Input n.1 port, Baffle n.3 ports, Spares (1bottom,2short) n.1 port, Harvest valve
Design	Borosilicate Glass Jacketed Vessel with Super Duplex and AISI316
Materials	Borosilicate Glass, Super Duplex, AISI316
Sensors lenght (mm)	
pH	225
dO <sub>2</sub>	225
Dimensions for autoclave (with Condenser)	
Height (mm)	660
Diameter (mm)	280
Thermoregulation	
Control	PID Control - Accuracy 0,1 °C Thermobox (flat) / water jacketed with electric heaters (stirred vessel)
Gas Control & Gas Mixing	
Sparger and overlay Gas Control	TMFC
Gas Mixing (Air,CO <sub>2</sub> ,O <sub>2</sub> ,N <sub>2</sub> )	n.1 TMFC + n. solenoid valves or n° of TMFC
Aeration system	Micro holes Type with 0,2 µm filter
Exhaust	Condenser and 0,2 µm filter
Peristaltic Pumps	
	n.4 Watson Marlow type 114, fixed speed, max. 60 rpm, volumetric flow 0,5-51 ml/min, function assignable from software (optional) Watson Marlow type 313 FDM/D, max. speed 350 rpm, volumetric flow 1,5-1750 ml/min, function assignable from software
Controller	
Master Control Module	From 1 to 24 units - 35x37xh36 cm
HMI with Leonardo software	Operate interface 58x15xh48 cm with 24" monitor

## Controls

INTEGRATED IN THE PCS	Temperature	
	Sensor	PT100
	Control system	Measuring resident in Leonardo 3.0 software
	Control range	0 - 150°C
	pH	
	Sensor	Digital sensor
	Control system	Measuring resident in Leonardo 3.0 software
	Control range	0 - 14
	Operation temperature	0 - 130°C
	Pressure range	0 - 6 bar
Actuator	Cascade to peristaltic pumps for the addition of acid/base solutions or gas (CO <sub>2</sub> )	
INTEGRATED IN THE PCS	dO <sub>2</sub>	
	Sensor	Digital Optical sensor
	Control system	Measuring resident in Leonardo 3.0 software
	Control range	0,05 - 300% air saturation
	Operation temperature	-10 - 130°C
	Pressure range	0 - 12 bar
	Actuator	Cascade to RPM, Gas Control, feedings,ect
	Antifoam/Level	
	Sensor	Solaris sensor
	Control	Measuring resident in Leonardo 3.0 software
EXTERNAL MODULAR BOX	Redox (ORP)	
	Sensor	Digital sensor
	Control system	Measuring resident in Leonardo 3.0 software
	Control range	±2000 mV
	Operation temperature	- 10 -130°C
	Pressure range	≤ 6 bar
	Conductivity	
	Sensor	Digital sensor
	Control system	Measuring resident in Leonardo 3.0 software
	Control range	1 - 3000 µS/cm
Operation temperature	0 -130°C	
EXTERNAL MODULAR BOX	dCO <sub>2</sub>	
	Sensor	Analog sensor
	Control system	Measuring resident in Leonardo 3.0 software
	Control range	0,00-200% saturation
	Operation temperature	-20.0-150°C
	Pressure range	0 - 4 bar
	Weight	
	Sensor	Digital Balance
	Control	Measuring resident in Leonardo 2.0 software
	Peristaltic pumps	
WM 114	10-60 rpm	
WM 313 FDM/D	45-350 rpm	

## Chiller

- Optionally ELARA can be equipped with a chiller for heat removal from your culture minimizing lab water usage
- Using this system you don't need a water supply line in your lab
- Cost-effective cooling of fermenters
- Easy operation
- Refrigerant level monitoring



Chiller data sheet	
Working temperature range	-10°C / +40°C
Temperature stability	±0.5
Power consumption	0.7 kW
Filling volume range	2-8 L
Cooling output at 20°C measured with ethanol	0.25-0.60 kW
Cooling output at 10°C measured with ethanol	0.20-0.50 kW
Cooling output at 0°C measured with ethanol	0.15-0.36 kW
Cooling output at -10°C measured with ethanol	0.09-0.15 kW



# STANDARD STERILIZABLE IN PLACE SOLUTIONS



## GENESIS

The **GENESIS** series offers a transitional system for scaling from benchtop to SIP systems. Available in sizes from 7.5 to 20 L total volume, Genesis is meant to offer a SIP platform, on the benchtop space. Sterilization can be achieved via steam or alternatively by electric heaters.

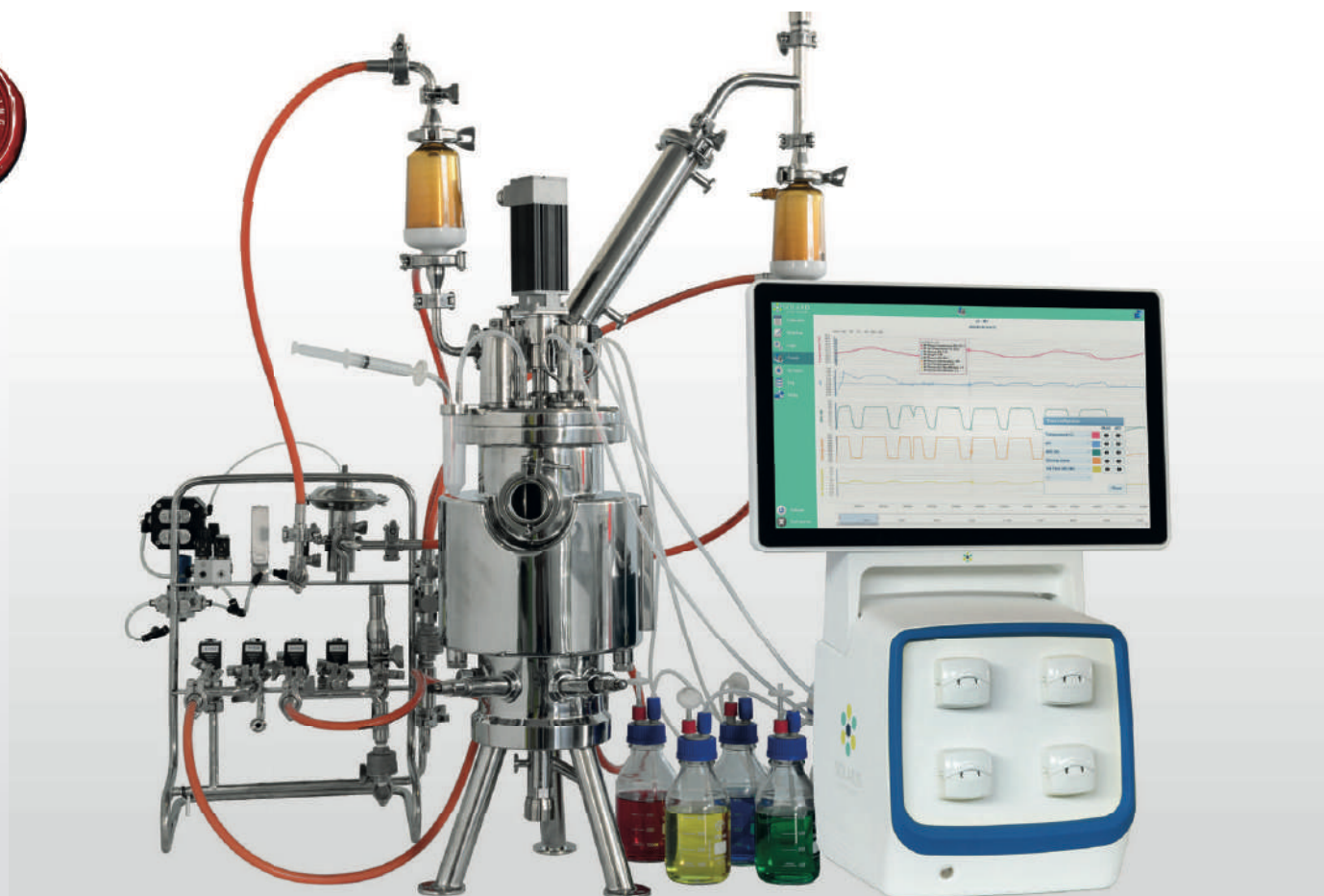

**GENESIS** is an ideal partner for microbial fermentation as well as animal, plant and insect cell cultivation. Typical applications includes the following:

- Education
- Basic research
- Scale-up and scale-down studies
- Process development and optimization

**GENESIS** can be used for:

- Biopharmaceutical
- Biofuels research and manufacturing
- Vaccines
- Food and beverage biotechnologies
- Bioremediation
- Bioplastics
- Cosmeceutical
- Nutraceutical

**WHY TO INVEST  
IN THIS PRODUCT**

The best ratio  
**Quality/  
Capability/Price**  
on the market

**Automatic  
sterilization**  
through electrical heaters  
(no need for an  
external steam source)  
or by steam

## Benefits

Powerful/ Accurate **brushless motor**, from 1 to 2000 RPM.  
Online absorbed Torques (Nm) and Power (W) measurements  
obtaining an indirect density indication of the culture broth.

Different gas mixing strategies with  
up to 5 TMFC

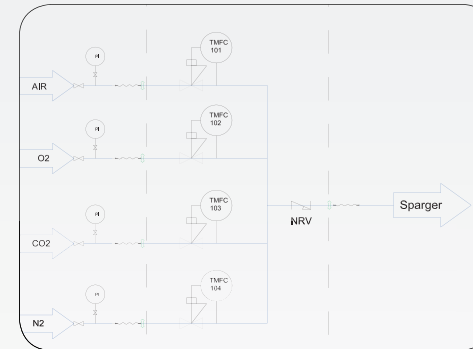

Sampling system



Illuminated side glass

Modbus Digital  
sensors



External additional boxes parameters for  
future PCS upgrade including dCO<sub>2</sub>, Cell  
Density, Weight, Peristaltic pumps, ect

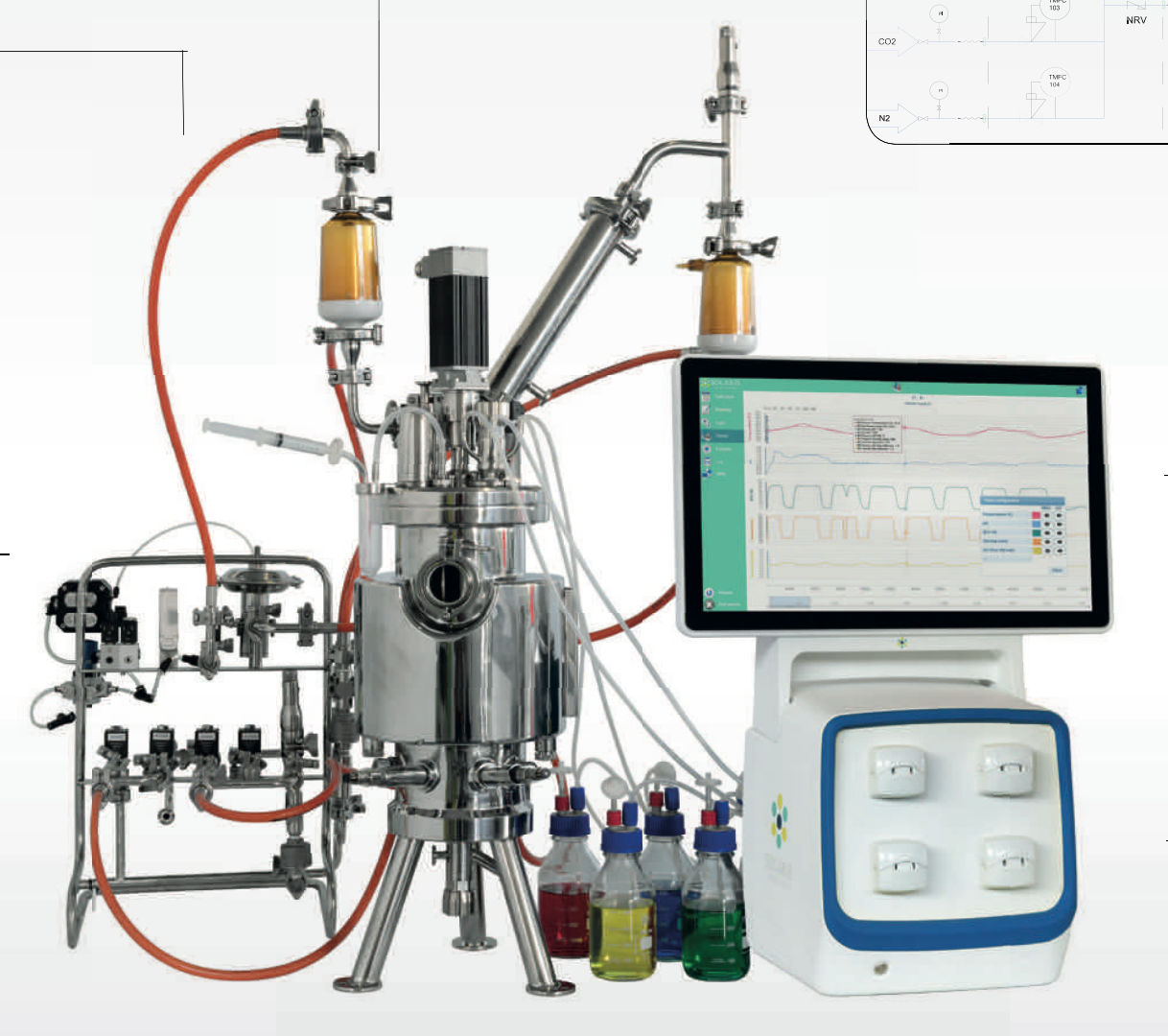

Compact and modular PCS

### Double jacket (side-bottom)

Increased heat transfer efficiency  
It ensures optimal temperature  
control and sterilization even at  
minimum volumes

N.4 assignable Watson Marlow pumps in  
entry level

Harvest valve in entry level  
optionally SIP

Automatic sterilization by steam  
or alternatively through electrical  
heaters



## SALAS - Solaris Sterile Needle Free Additions System

NEEDLE  
FREE

Genesis is supplied with SALAS, a 4 channel, needle free additions system for inoculums, feedings, pH corrective solutions, antifoam, etc.

EASY & QUICK  
OPERATION

SALAS allows an easy and quick connection between the feeding solution and the vessel top lid.

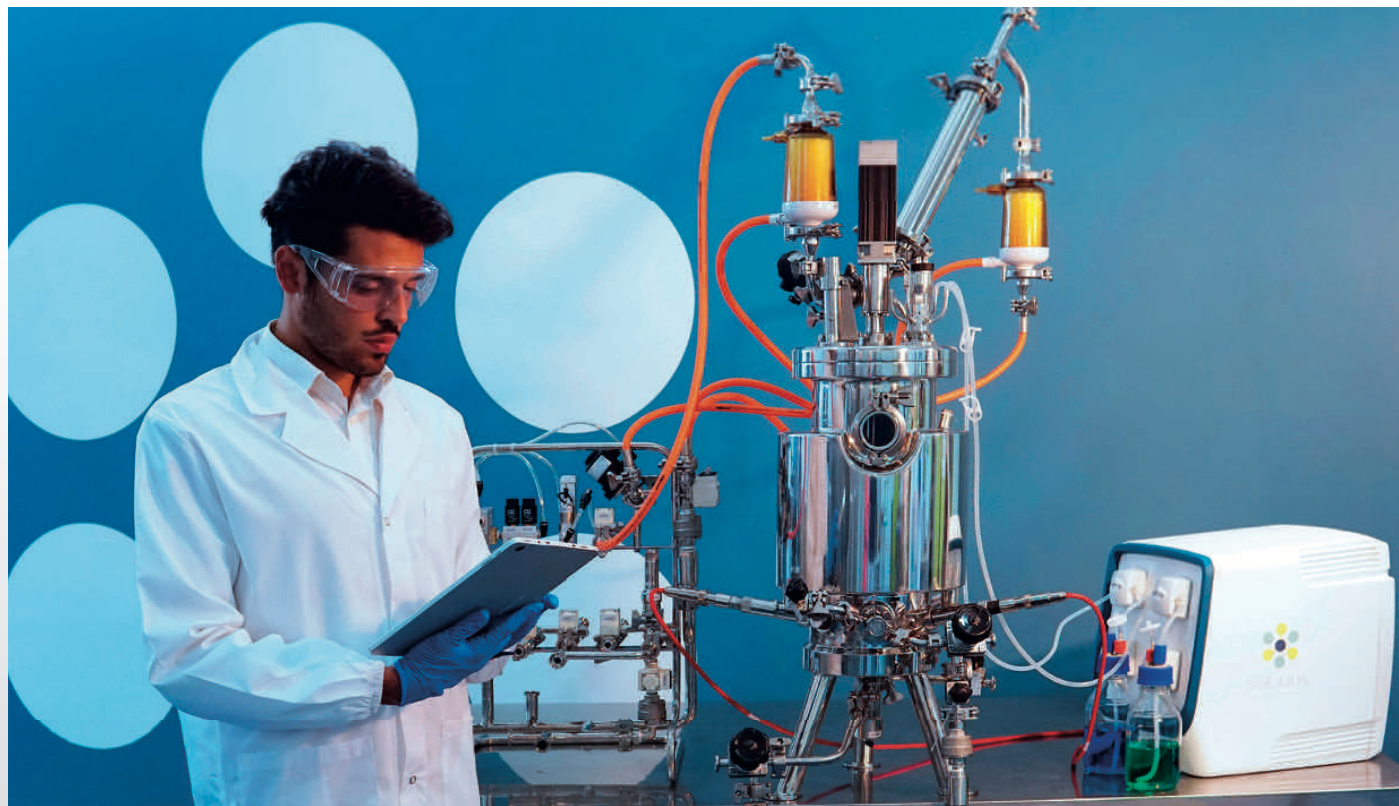
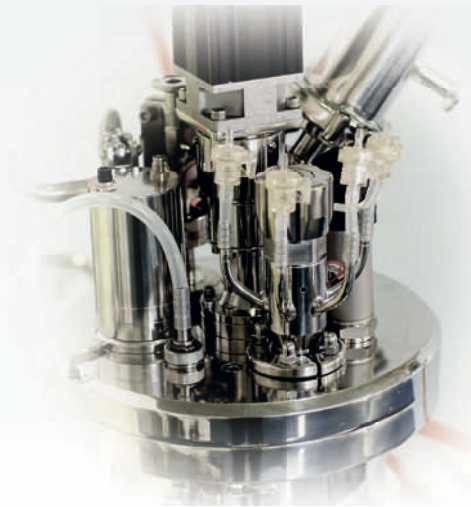

## Leonardo 3.0

### USER-FRIENDLY SOFTWARE

Solaris controlling software offers a simply laid out, yet powerful platform for experimental design planning and process control.

The graphical user interface enables the intuitive selection and adjustment of control functions.

Extracted data is compatible with Window Excel but, in addition, Solaris offers a platform where fermentation data can be easily exported in real time and thus managed. This software is included in the supply and can be installed on an unlimited number of the client's PC or laptops.

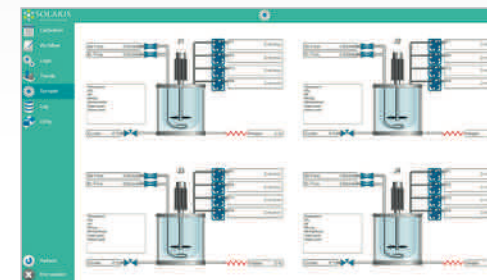

### Do it parallel: smarter..faster

Leonardo allows intuitive and time-saving parallel operations. Up to 24 independent fermentations/cultivations can be carried out simultaneously.

### Why a digital sensor?

Digital sensors (including Cell Density products) have been integrated to the Solaris PCS and Leonardo controlling software, giving the user many benefits over traditional analog sensor outputs. Such benefits include a robust communication protocol not susceptible to signal loss, in-software sensor diagnostic information, parallel calibration/batch calibrations and more.

Sensor life  
traceability

Reducing  
background noise

### Gas mixing

Hardware and software adaptability are key to enable the best aeration strategy for each process. Thermal mass flow controllers (TMFC) allow precise flow rate control of individual gasses. Up to 5 TMFC's can be configured within each PCS cube and integrated to the controlling software. The powerful software and control platform allows precise cascade adjustment of multiple parameters to manage gas transfer, OTR, kLa, etc.

- n.1 TMFC included in "entry" level system; additional available as optional
- Automatic gas mixing algorithms
- Various agitator and baffle designs available or numbers of TMFC
- Toro, sintered and other spargers available

## Data sheet

Vessel				
Solaris Code	Genesis 7.5	Genesis 10.0	Genesis 15.0	Genesis 20.0
Total Volume (liters)	7.5	10.0	15.0	20.0
Ratio D/H	1:2,5	1:2,5	1:2,5	1:2,5
Min. Working Volume (liters)	1.3	1.8	2.7	3.6
Max. Working Volume (liters)	5.6	7.5	11.25	15
Working temperature range	0-135°C			
Working pressure range	2 bar			
Design	Stainless Steel Jacketed Vessel			
Materials	Parts in contact with the culture AISI 316 L - other parts AISI 304			
Finishing	All parts in contact with the culture: Ra < 0,5 µm ; External: Ra < 0,6 µm Mirror polished			
Ports and Connections				
	Connection	Description		
Vessel lid	PG13	Antifoam		
	TC 3/4"	Safety valve		
	TC 3/4"	Gas-out		
	TK 3/4"	SALAS-Solaris Sterile liquid addition		
Upper side wall	TC 1"	Pressure probe		
	DN 52	Stirrer		
	TC 1/2"	Overlay gas inlet		
	TC 1/2"	Sparger		
Lower side wall	In gold	Sight glass		
	In gold	Sight glass		
	Hygenic socket	pH probe		
	Hygenic socket	dO probe		
	Hygenic socket	spare probe		
	Hygenic socket	spare probe		
Vessel bottom	Temperature housing	PT100		
	TC 3/4"	Harvest/sampling valve		
	TC 1/2"	Steam in		
Jacket in-out	TC 1/2"	Water in		
	TC 1/2"	Jacket out		
	1/2" G	Electric heaters		
	1/2" G	Electric heaters		
	1/2" G	Electric heaters		
Stirring				
Drive	Brushless Motor, Direct Assembly, 1-1500 rpm (bacterial), 1-500 (cell cultures)			
Power	208W ( 7.5-10L ) ; 622W ( 15-20L )			
Impellers	Select from: Rushtons impellers , Marine Impellers, Pitched blade			
Thermoregulation				
Control	PID Control - Accuracy 0,1 °C Jacket steam and electric heaters / cooling source			
Gas Control & Gas Mixing				
Sparger and overlay Gas Control	TMFC			
Gas Mixing (Air,CO <sub>2</sub> ,O <sub>2</sub> ,N <sub>2</sub> )	n.1 TMFC + n.4 solenoid valves, n° of TMFC			
Sparger type	Select from: Toro type (ring), synered microbubbling both provided with 0,2 µm filter			
Exhaust	Condenser and 0,2 µm filter			
Controller				
Master Control Module	From 1 to 24 units - 35x37xh36 cm			
HMI with Leonardo software	Operate interface 58x15xh48 cm with 24" monitor			

## Controls

INTEGRATED IN THE PCS	Temperature	
	Sensor	PT100
	Control system	Measuring resident in Leonardo 3.0 software
	Control range	0 - 150°C
	pH	
	Sensor	Digital sensor
	Control system	Measuring resident in Leonardo 3.0 software
	Control range	0 - 14
	Operation temperature	0 - 130°C
	Pressure range	0 - 6 bar
	Actuator	Cascade to peristaltic pumps for the addition of acid/base solutions or gas (CO <sub>2</sub> )
	dO <sub>2</sub>	
	Sensor	Digital Optical sensor
	Control system	Measuring resident in Leonardo 3.0 software
	Control range	0,05 - 300% air saturation
Operation temperature	-10 - 130°C	
Pressure range	0 - 12 bar	
Actuator	Cascade to RPM, Gas Control, feedings,ect	
Antifoam/Level		
Sensor	Solaris sensor	
Control	Measuring resident in Leonardo 3.0 software	
Redox (ORP)		
Sensor	Digital sensor	
Control system	Measuring resident in Leonardo 3.0 software	
Control range	±2000 mV	
Operation temperature	- 10 -130°C	
Pressure range	≤ 6 bar	
Conductivity		
Sensor	Digital sensor	
Control system	Measuring resident in Leonardo 3.0 software	
Control range	1 - 3000 µS/cm	
Operation temperature	0 -130°C	
Pressure range	0 - 20 bar	
dCO <sub>2</sub>		
Sensor	Analog sensor	
Control system	Measuring resident in Leonardo 3.0 software	
Control range	0,00-200% saturation	
Operation temperature	-20.0-150°C	
Pressure range	0 - 4 bar	
Cell density		
Sensor	Digital sensor	
Control system	Measuring resident in Leonardo 3.0 software	
Pressure range	0-3 bar (option 1) 0-10 bar (option 2)	
Operation temperature	0-60°C (option 1) 0-80°C (option 2) (max. sterilization temperature 135°C)	
Option 1	Dencytee: Total cell density based on turbidity (Two ranges: 10 <sup>^5</sup> to 10 <sup>^8</sup> mammalian cells/ml - 0.5 to 100 g/L dry weight)	
Option 2	Incyte: Viable cell density based on capacitance (Two ranges: 5x10 <sup>^5</sup> to 8x10 <sup>^8</sup> mammalian cells/ml - 5 to 200 g/L dry weight)	
Weight		
Sensor	Digital Balance	
Control	Measuring resident in Leonardo 3.0 software	
Peristaltic pumps		
WM 114	10-60 rpm	
WM 313 FDM/D	45-350 rpm	

EXTERNAL MODULAR BOX

## Chiller

- Optionally GENESIS can be equipped with a chiller for heat removal from your culture minimizing lab water usage
- Using this system you don't need a water supply line in your lab
- Cost-effective cooling of fermenters
- Easy operation
- Refrigerant level monitoring



Chiller data sheet	
Working temperature range	-10°C / +40°C
Temperature stability	±0.5
Power consumption	0.7 kW
Filling volume range	2-8 L
Cooling output at 20°C measured with ethanol	0.25-0.60 kW
Cooling output at 10°C measured with ethanol	0.20-0.50 kW
Cooling output at 0°C measured with ethanol	0.15-0.36 kW
Cooling output at -10°C measured with ethanol	0.09-0.15 kW
Pump pressure max.	0.35-1.30 bar
Pump flow max.	16-35 L/min.



# SINGLE USE FERMENTERS/BIOREACTORS

## BLACKJAR & BLACKBOX

**BlackJar** vessels: configurable and customizable pre-sterilized single use ridged wall bioreactors and fermenters.

**BlackBox** - Solaris single use PCS, parallel process control platform.

The BlackBox PCS offers a versatile and powerful platform for single use systems. There are multiple configurations available for various process sensor outputs, thermoregulation and agitator connectivity, etc. BlackJar offers standard and customizable fermentation and cell culture configurations. BlackBox and BlackJar are compatible with any SU platform, but offer the most versatility in conjunction with each other.



### Benefits

- Eliminate cross contamination risk
- Drastically shorten turnaround time between runs
- Integration of Hamilton digital communication as optional
- Flexible PCS I/O design for many vessel sensor configurations





BlackJar vessels are customizable, pre-sterilized, single-use, ridged wall bioreactor/fermenter vessels available in a range of sizes from 50 ml to 30 L.

## Materials

Polycarbonate and Nylon materials

## Sterilization and Validation

SU components are sterilized via high precision E-beam irradiated in dual polyester foil bags. Media contact materials are ISO10993, USP class VI.

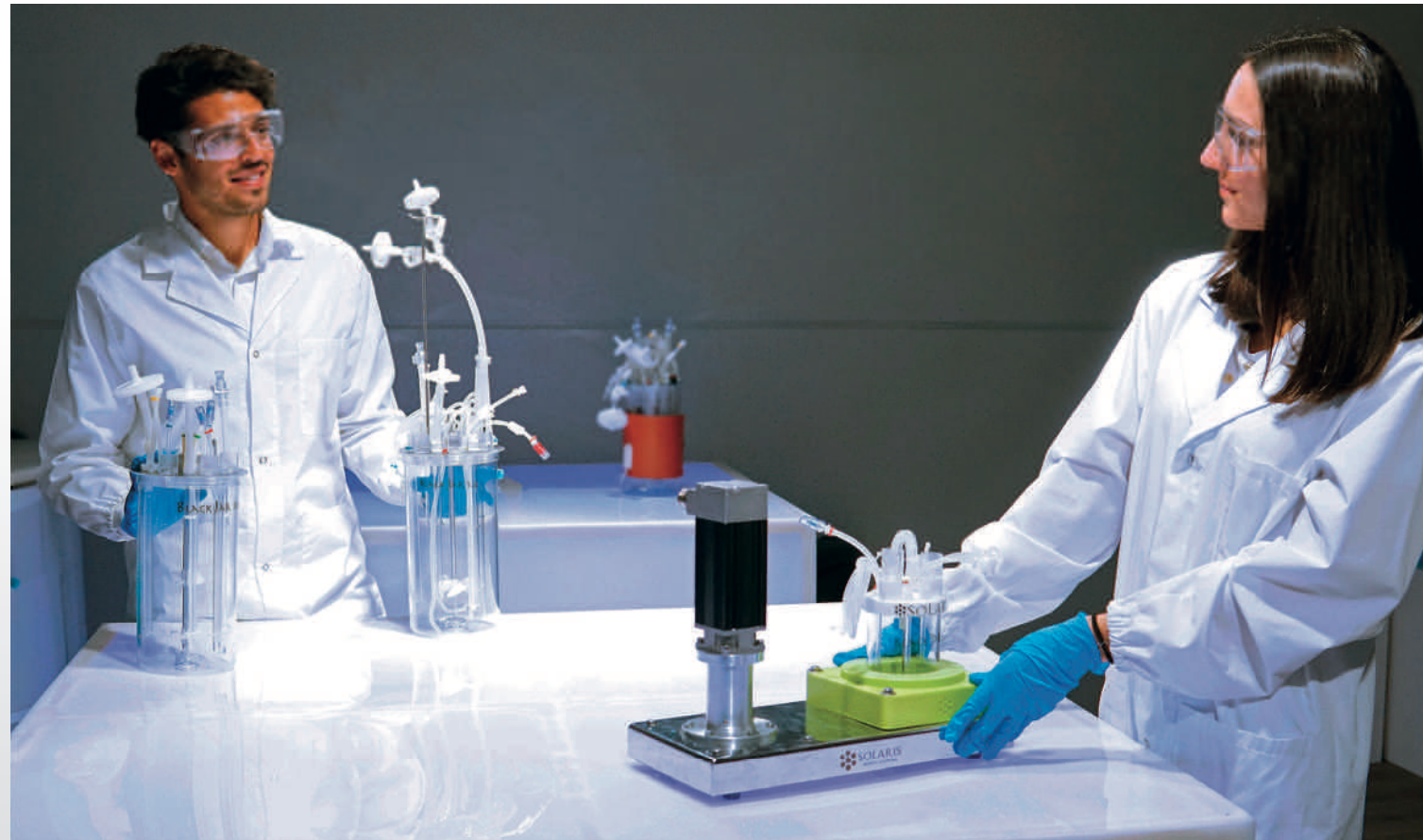

## Benefits

- Single Use bioreactor and fermenter vessels available in 500 ml, 3.2 L, 5.7 L, 30 L, and other total volumes.
- Option to fully customize head plate configuration, impellers, spargers, thermoregulation system, sensors, etc.
- Standard SU bioreactor (SUB) and SU fermenter (SUF) configurations available.
- Many PG 13.5 head plate ports.
- Optional customer preferred dO2 and pH single use sensors integrated and pre-sterilized.
- Single use optical dO2 solution available.
- Long silicon tubing for head plate inlets and outlets.
- Adaptation to any agitator motor.
- Head plate drive or magnetic bottom drive agitator options available.
- Adaptation to any thermoregulation system, electric or liquid jacket.
- Utilization of the best polycarbonate materials pre-sterilized via e-beam radiation.





## BlackBox Unique Process Control System (PCS) for single use

**BlackBox** is a highly adaptable single use Process Control System (PCS) with a flexible In/out design.

The **BlackBox** PCS offers a versatile and powerful platform for single use systems. There are multiple configurations available for various process sensor outputs, thermoregulation and agitator connectivity.

**BlackBox** is compatible with any SU vessels on the market like BioBLU®, UniVessel®, CellReady®, etc., but most flexible in conjunction with BlackJar.



## Leonardo 3.0

### USER-FRIENDLY SOFTWARE

Solaris controlling software offers a simply laid out, yet powerful platform for experimental design planning and process control. The graphical user interface enables the intuitive selection and adjustment of control functions. Extracted data is compatible with Window Excel but, in addition, Solaris offers a platform where fermentation data can be easily exported in real time and thus managed. This software is included in the supply and can be installed on an unlimited number of the client's PC or laptops.



Workflow page

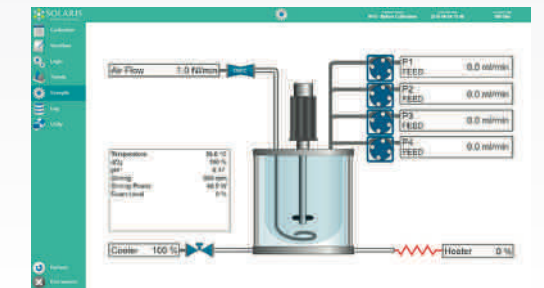

Synoptic page top agitation

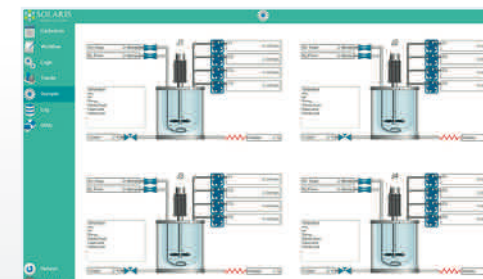

Parallel synoptic

### Do it parallel: smarter..faster

Leonardo allows intuitive and time-saving parallel operation. Up to 24 independent fermentation/cultivations can be carried out simultaneously.



### Do it wireless!

Increase mobility: users have the option to access the platform remotely, via PC, tablet, phone. Remote access is multi-level password protected.

## BlackBox Data sheet

PCS	
Cabinet	S Cube -Black Satin Stainless Steel h 350mm; l 350mm, d 350mm
Stirring	
Drive	Brushless Motor, 0-500 rpm for cultivation or 0-2.000rpm for fermentation (top direct or MST coupling) Magnetic stirred table (MST)
Aeration	
Gas control	n.1 TMFC
Gas mixing (AIR, N2, CO2, O2)	numbers of TMFC (up to 5, sparger/overlay)
Off-gas filter heater	
Numbers of TMFC (up to 5)	
Off-gas filter heater	
Thermoregulation	
Temperature sensor Pt100 (length depending from SUB/SUF size)	
PID Control for Heating and Cooling, Accuracy: 0.1°	
Heating blanket	
Re-Usable-Jacket with electrical heaters	
Sensors Inputs	
Input for Hamilton VisiFerm dO ARC 220 mm digital sensor (no sensor included)	
Input for Polarographic/Ampheometric analogue dO probe (BNC and K8 connectors; no sensor included)	
Input for analogue electrolyte-based pH (BNC and K8 connectors; no sensor included)	
Input for digital electrolyte-based pH (no sensor included)	
Input for level sensor (no sensor included)	
Input for foam control (no sensor included)	
Pumps	
N.4 Watson Marlow peristaltic pumps, fixed speed	
External additional peristaltic pumps	
Weight	
Input for Weight measurement	
Digital balance 0,1 gr. accuracy	
Communication	
n.4 Analog Input 0-10V and 0-20 mA/4-20 mA and n.4 Analog Output 0-10V and 0-20 mA/4-20 mA	
PC & Software	
HMI	From 1 to 24 units - 35x37xh36 cm- HMI with 24" monitor
Software	SCADA Solaris Software Control Leonardo 3.0
Solaris Logic Parser Software	
Solaris Fermentation Manager	
Data Extraction	Through USB port or Ethernet/Wi-Fi
Graphs Trends, On line displaying and Printing	
On line Parameters Calibration	
Alarms Management	
Events Recording	
Multipasswords Levels	

DEFAULT SET UP

## Controls

OPTIONAL (BUILT IN)	
Gas Mixing	
up to 5 TMFC's (sparger and overlay)	
Redox (ORP)	
Sensor	Digital sensor
Sensitivity	57 to 59 mV/pH
Control system	Measuring resident in Leonardo 3.0 software
Control range	±2000 mV
Operation temperature	- 10 -130°C
Pressure range	≤ 6 bar
Conductivity	
Sensor	Digital sensor
Accuracy	±3%
Control system	Measuring resident in Leonardo 3.0 software
Control range	1 - 3000 µS/cm
Operation temperature	0 -130°C
Pressure range	0 - 20 bar
Stirring	
Stirring through Magnetic Stirrer Table	
dCO <sub>2</sub>	
Sensor	Analog sensor
Accuracy	±10% (pCO <sub>2</sub> 10-900 mbar) ≥ ±10%(pCO <sub>2</sub> > 900 mbar)
Control system	Measuring resident in Leonardo 3.0 software
Control range	0,00-200% saturation
Operation temperature	-20.0-150°C
Pressure range	0 - 4 bar
Cell density	
Sensor	Digital sensor
Accuracy	Mammalian cells in suspension ±5·10 <sup>4</sup> cells/ml - Fermentation ±0.05 g/l dry weight
Control system	Measuring resident in Leonardo 2.0 software
Pressure range	0-3 bar (option 1) 0-10 bar (option 2)
Operation temperature	0-60°C (option 1) 0-80°C (option 2) (max. sterilization temperature)
Option 1	Dencytee: Total cell density based on turbidity (Two ranges: 10 <sup>5</sup> to 10 <sup>8</sup> mammalian cells/ml - 0.5 to 100 g/L dry weight)
Option 2	Incyte: Viable cell density based on capacitance (Two ranges: 5x10 <sup>5</sup> to 8x10 <sup>8</sup> mammalian cells/ml - 5 to 200 g/L dry weight)
Weight	
Sensor	Digital Balance
Accuracy	±0.2 g
Control	Measuring resident in Leonardo 2.0 software
Peristaltic pumps	
WM 114	fixed speed, max. 60 rpm

OPTIONAL (EXTERNAL)

## Chiller

- Optionally the BlackJar can be equipped with a chiller for heat removal from your culture minimizing lab water usage
- Using this system you don't need a water supply line in your lab
- Cost-effective cooling of fermenters
- Easy operation
- Refregerant level monitoring



Chiller data sheet	
Working temperature range	-10°C / +40°C
Temperature stability	±0.5
Power consumption	0.7 kW
Filling volume range	2-8 L
Cooling output at 20°C measured with ethanol	0.25-0.60 kW
Cooling output at 10°C measured with ethanol	0.20-0.50 kW
Cooling output at 0°C measured with ethanol	0.15-0.36 kW
Cooling output at -10°C measured with ethanol	0.09-0.15 kW
Pump pressure max.	0.35-1.30 bar
Pump flow max.	16-35 L/min.



# PRODUCTS

## PILOT AND INDUSTRIAL FERMENTERS/BIOREACTORS

Solaris' pilot and industrial scale fermenters and bioreactors have been designed to simplify scale-up related challenges. "Standard" systems can be tailored via a multitude of components and ancillary equipment options. Solaris also specializes in fully customized systems, built to work within a broad range of applications. Customized vessels designs, associated skids, impeller configurations, communication and connectivity protocols, etc. are all available.

Systems are designed for in situ sterilization, configured to the application, and can be managed automatically through the controlling software. Full cGMP validation and supporting documentation packages are available and specified per each application's regulatory needs. Systems are configurable for each application and organism, and offer continuity from smaller scale platforms.

**M SERIES**



**S SERIES**



**I SERIES**



# STANDARD STERILIZABLE IN PLACE SOLUTIONS



## M SERIES

**M series** bioreactors and fermenters are Solaris' "standard" pilot plant scale platforms. There are 6 available standard vessel sizes ranging from 30 up to 200 L total volumes, completely configurable with an extensive range of options and accessories.

**M Series** typical applications includes the following:

- Scale-up and scale-down studies
- Pilot plant
- Small productions

**M series** can be used for:

- Biopharmaceutical
- Biofuels
- Food industry
- Bioremediation
- Bioplastic
- Cosmeceutical
- Nutraceutical

**M Series**  
your  
scaling up  
guide

30 liters

50 liters

75 liters

100 liters

150 litres

200 liters





TK connection rather than TC ensures a better cleanability and easier sterilization

Different gas mixing strategies with up to 5 TMFC

Automatic mechanical seal lubrication with steam condensate loop



19" coloured touch screen industrial HMI  
SBC16: smart controller designed to provide a high level of automated management of the fermentation/ cultivation processes  
**Customizable PID** or factory default

Multiple sensors options  
pH, dO2, Redox, Total Cell density,  
Viable Cell density, Conductivity, dCO2

Re-sterilizable addition system  
(steam bridge)

**Double jacket (side/bottom)**  
Increased heat transfer efficiency  
It ensures optimal temperature control and sterilization even at minimum volumes

**Top agitation, accurate brushless motor**, from 1 to 2000 RPM.  
Online absorbed Torques (Nm) and Power (W) measurements obtaining an indirect density indication of the culture broth.

N.2 heat exchangers and recirculating pump



Separate drains  
cooling return, condense to waste, hot condense return

Compact design

Tri-Clamp stainless steel piping cGMP designed to provide a smooth, and non-contaminating environment. Provides leak-tight connections and it is flexible and adaptable to other forms of piping.





# Modbus Digital sensors

## Why a digital sensor?

Digital sensors (including Cell Density products) have been integrated to the Solaris PCS and Leonardo controlling software, giving the user many benefits over traditional analog sensor outputs. Such benefits include a robust communication protocol not susceptible to signal loss, in-software sensor diagnostic information, parallel calibration/batch calibrations and more.



**Sensor life traceability**

**Reducing background noise**

# Gas mixing

Hardware and software adaptability are key to enable the best aeration strategy for each process. Thermal mass flow controllers (TMFC) allow precise flow rate control of individual gasses. Up to 5 TMFC's can be configured within each PCS cube and integrated to the controlling software. The powerful software and control platform allows precise cascade adjustment of multiple parameters to manage gas transfer, OTR, kLa, etc.

- n.1 TMFC included in "entry" level system; additional available as optional
- Various agitator and baffle designs available
- Automatic gas mixing algorithms
- Toro, sintered and other spargers available



# Leonardo 3.0

## USER-FRIENDLY SOFTWARE

Solaris controlling software offers a simply laid out, yet powerful platform for experimental design planning and process control. The graphical user interface enables the intuitive selection and adjustment of control functions. Extracted data is compatible with Window Excel but, in addition, Solaris offers a platform where fermentation data can be easily exported in real time and thus managed. This software is included in the supply and can be installed on an unlimited number of the client's PC or laptops.



Workflow page





## Data sheet

Vessel						
Solaris Code	M serie 30	M serie 50	M serie 75	M serie 100	M serie 150	M serie 200
Total Volume (liters)	30,00	50,00	75,00	100,00	150,00	200,00
Ratio D/H	1:3.0	1:3.0	1:3.0	1:3.0	1:3.0	1:3.0
Min. Working Volume (liters)	4,50	7,50	11,00	15,00	22,00	30,00
Max. Working Volume (liters)	21,00	36,00	55,00	75,00	110,00	145,00
Working temperature range	0-135°C					
Working pressure range	Up to 2 bar					
Design	Stainless Steel Jacketed Vessel					
Materials	Parts in contact with the culture AISI 316 L - other parts AISI 304					
Stirring						
Drive	Brushless Motor, Top Direct Assembly					
Impellers	Select from: Rushtons impellers, Marine Impellers, Pitched blade					
Thermoregulation						
Control	PID Control - Accuracy 0,1 °C Jacket steam and electric heaters / cooling source					
Gas control & gas mixing						
Sparger and overlay Gas Control	TMFC					
Gas Mixing (Air,CO <sub>2</sub> ,O <sub>2</sub> ,N <sub>2</sub> )	n.1 TMFC + n.4 solenoid valves, n° of TMFC					
Sparger type	Select from: Toro type (ring), syntered microbubbling both provided with 0,2 µm filter					
Exhaust	Condenser and 0,2 µm filter (option)					
Options						
Double mechanical seal						
Vessel empty sterilization						
Electrical heaters						
Resterilizable addition system: Steam bridge (manual or automatic)						
Peristaltic pumps (WM 114, WM 313, WM 520)						
Gravimetric flow control (feed rate controlled through weight measurement)						
Manual and automatic SIP harvest and sampling valves						
CIP system: removable spray balls or integrated system (recirculating pump and n.2 removable spray balls + software automation)						

## Controls

Temperature	
Sensor	PT100
Control system	Measuring resident in Leonardo software
Control range	0 - 150°C
pH	
Sensor	Digital sensor
Control system	Measuring resident in Leonardo software
Control range	0 - 14
Operation temperature	0 - 130°C
Pressure range	0 - 6 bar
Actuator	Cascade to peristaltic pumps for the addition of acid/base solutions or gas (CO <sub>2</sub> )
dO <sub>2</sub>	
Sensor	Digital Optical sensor
Control system	Measuring resident in Leonardo software
Control range	0,05 - 300% air saturation
Operation temperature	-10 - 130°C
Pressure range	0 - 12 bar
Actuator	Cascade to RPM, Gas Control, feedings,ect
dCO <sub>2</sub>	
Sensor	Analog sensor
Control system	Measuring resident in Leonardo software
Control range	0,00-200% saturation
Operation temperature	-20.0-150°C
Pressure range	0 - 4 bar
Cell density	
Sensor	Digital sensor
Control system	Measuring resident in Leonardo software
Pressure range	0-3 bar (option 1) , 0-10 bar (option 2)
Option 1	Total cell density based on turbidity (Two ranges: 10 <sup>^5</sup> to 10 <sup>^8</sup> mammalian cells/ml - 0.5 to 100 g/L dry weight)
Option 2	Viable cell density based on capacitance (Two ranges: 5x10 <sup>^5</sup> to 8x10 <sup>^8</sup> mammalian cells/ml - 5 to 200 g/L dry weight)
Redox (ORP)	
Sensor	Digital sensor
Control system	Measuring resident in Leonardo software
Control range	±2000 mV
Operation temperature	- 10 -130°C
Pressure range	≤ 6 bar
Conductivity	
Sensor	Digital sensor
Control system	Measuring resident in Leonardo software
Control range	1 - 3000 µS/cm
Operation temperature	0 -130°C
Pressure range	0 - 20 bar
Weight	
Sensor	n.3 load cells
Control	Measuring resident in Leonardo software
Antifoam/Level	
Sensor	Solaris sensor
Control	Measuring resident in Leonardo software

## Set up your M series





# SIP & CIP CUSTOMIZABLE PILOT & INDUSTRIAL SCALE FERMENTERS/BIOREACTORS

## S-I SERIES

Solaris' **S and I SERIES** systems offer tremendous flexibility within pilot-production scale fermenter and bioreactor systems. Each S/I Series project is tailor-made for the complexities associated with each application. The Solaris industrial team closely collaborates with the client's design and engineering contacts to ensure all specifications are best suited for each process. Up to 30,000 L vessels and beyond - Solaris offers tailored, turn-key pilot and industrial scale systems.

**High quality**  
meets most sophisticated  
international standards

**WHY TO  
INVEST  
IN THIS PRODUCT**

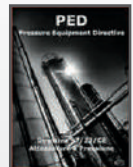

**100%**  
customized solutions



SBC-16

- Customizable vessels from 5L to > 30.000 L
- Configurable instrumentation for control and/or measurement, including pH, dO<sub>2</sub>, CO<sub>2</sub>, RPM, gas flow rates, temperature, antifoam, cell density (total and viable cells), weight, redox, conductivity, level, agitation, and much more. New and custom sensors are welcome.
- SCADA Control System SBC-16.
- Software management of data and trends.
- Configurable for microbial or cell culture applications; batch, fed-batch or continuous processes.
- Extensive range of accessories and ancillary equipment.

Smart controller for pilot and industrial plants. The SBC-16 system provides highly configurable automatic and manual management of fermentation/cell culture processes.

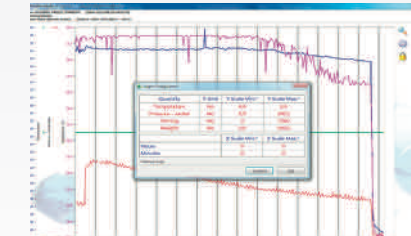
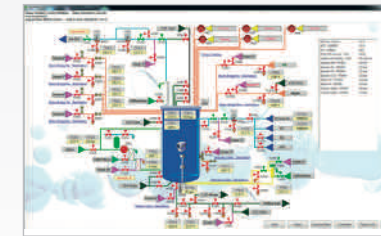



Each system is completely assembled and tested at the factory prior to installation. The units are then reassembled and retested after delivery to their final location. Systems are provided with a measurement and control system based on a SCADA supervisory platform connected through Ethernet and PLC. The SBC-16 software provides highly configurable automatic and manual management of fermentation/cell culture processes. The system is in accordance with CFR 21 Part 11.

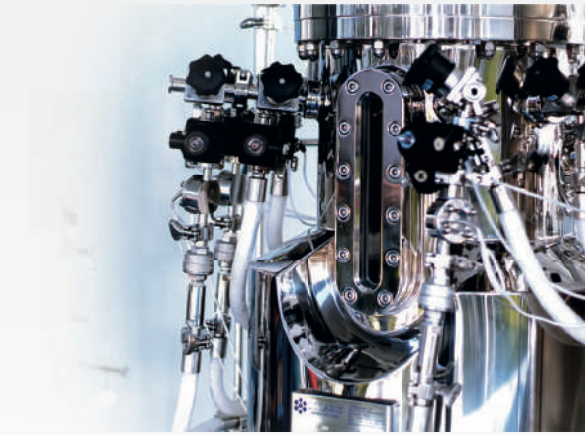
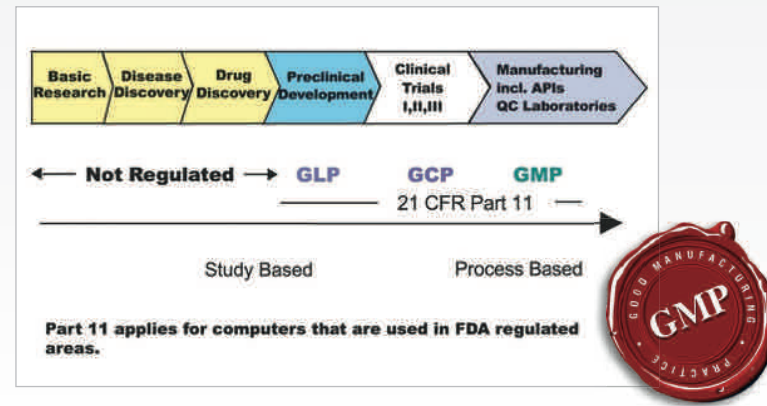

Front view  
Illuminated sideglass



Integrated videocamera



## GMP customized solutions

For GMP applications, Solaris offers compact solutions with an array of automation techniques for operability. Only top quality stainless steel is utilized, which undergoes the highest quality finishing available. Options include ancillary systems like steam bridge diaphragm valve groups, helping guarantee sterility during inoculation, sampling, harvesting, feeding, etc.

The system is also designed ergonomically such that operating procedures and maintenance can be performed efficiently.



Internal vessel design.



SIP Sampling bottle.







Front view side glass



Automatic mechanical seal lubrication with steam condensate loop



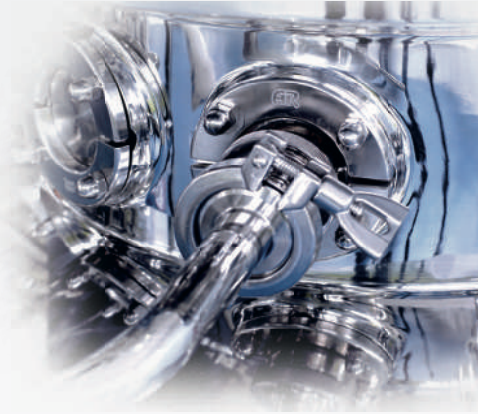

Tri clamp connection  
ensure a better cleanability  
and easier sterilization















Top view with illuminated side glass





# PRODUCTS AND SERVICES

PROCESS PLANTS  
METIS GAS ANALYZER  
DOWNSTREAM EQUIPMENT  
C.I.P. & S.I.P. SYSTEMS  
EDUCATION & TRAINING  
FERMENTATION AND BIOTECH DEVELOPMENT

PROCESS EQUIPMENTS



METIS GAS ANALYZER



DOWNSTREAM EQUIPMENT



C.I.P. & S.I.P. SYSTEMS



EDUCATION & TRAINING



FERMENTATION AND BIOTECH DEVELOPMENT





Process equipment, engineering and turn-key projects



Solaris is dedicated to the entirety of each project's path, from feasibility studies to equipment start-up.

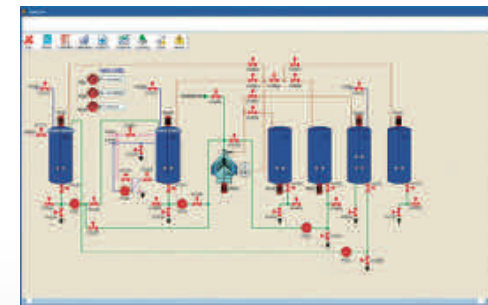

**CONSULTANCY**

- GMP audit
- Project URS preparation
- Feasibility Study
- Conceptual Design
- Process Simulation

**ENGINEERING & MANUFACTURING**

**HANDOVER**

- Commissioning
- Qualification /Validation
- Start-up & training

**THOUGHT**

**FEASIBILITY STUDY**

**PROJECT**

**MANUFACTURING**

**DELIVERY**

**PERSONNEL TRAINING**

**INSTALLATION & VALIDATION**





Atmospheric, over-pressure and vacuum tanks.  
Exceptional finishing by various methods of polishing  
guaranteed. Expertise in other equipment including: heat  
exchangers, mixing tanks, chemical reactors, customized  
systems, etc.  
PED, ATEX, SVTI, ASME, etc. certifications available.







O<sub>2</sub> concentration in the sample is measured by means of a transducer based on the zirconium dioxide properties of this gas, whereas CO<sub>2</sub> determination is based on the measurement of absorption of infrared (IR) radiation. SOLARIS METIS GA is equipped with an inlet line selector (multiplex) that allows the unit to be connected with up to 8 fermenters/bioreactors.

The concentration values of two gases are visualised on the monitor, analysed and represented graphically ON LINE, with subsequent calculation of the respiration coefficient.

- Acquisition of data in real time and conversion of the signals from the sensors applied to the process into values expressed in the specific units of measurement of each variable.
- Continuous graphic representation of the behaviour of O<sub>2</sub>, CO<sub>2</sub>, OUR, RQ, with possibility of changing configuration, scale, dynamic zoom and exporting graphs on a printer.
- Channel Configuration with possibility to set the reading parameters of gas to analyse.
- Probe Calibration
- Temperature Compensation
- Calculation of:
  - OUR (Oxygen Uptake Rate)
  - CER (Carbon Dioxide Evolution Rate)
  - RQ (Respiratory Quotient)



The Solaris METIS Gas Analyser is a combined CO<sub>2</sub> and O<sub>2</sub> analyzer, specifically designed for cultivation processes.



O<sub>2</sub> and CO<sub>2</sub> are the most frequently measured off gasses for process characterization and control (metabolism, substrate utilization, etc.). The measuring ranges of the METIS Gas Analyser are: 0 ÷ 10 or 15% for CO<sub>2</sub>, 21 ÷ 10% for O<sub>2</sub>. The system is based on well-proven, high quality transducers, and is designed with an extremely small internal volume, reducing overall response times.

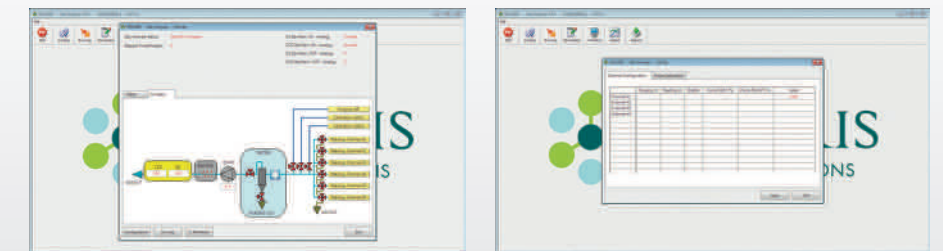



# AUTOMATIC AND FLEXIBLE TANGENTIAL FLOW FILTRATION SYSTEM

# KRONOS

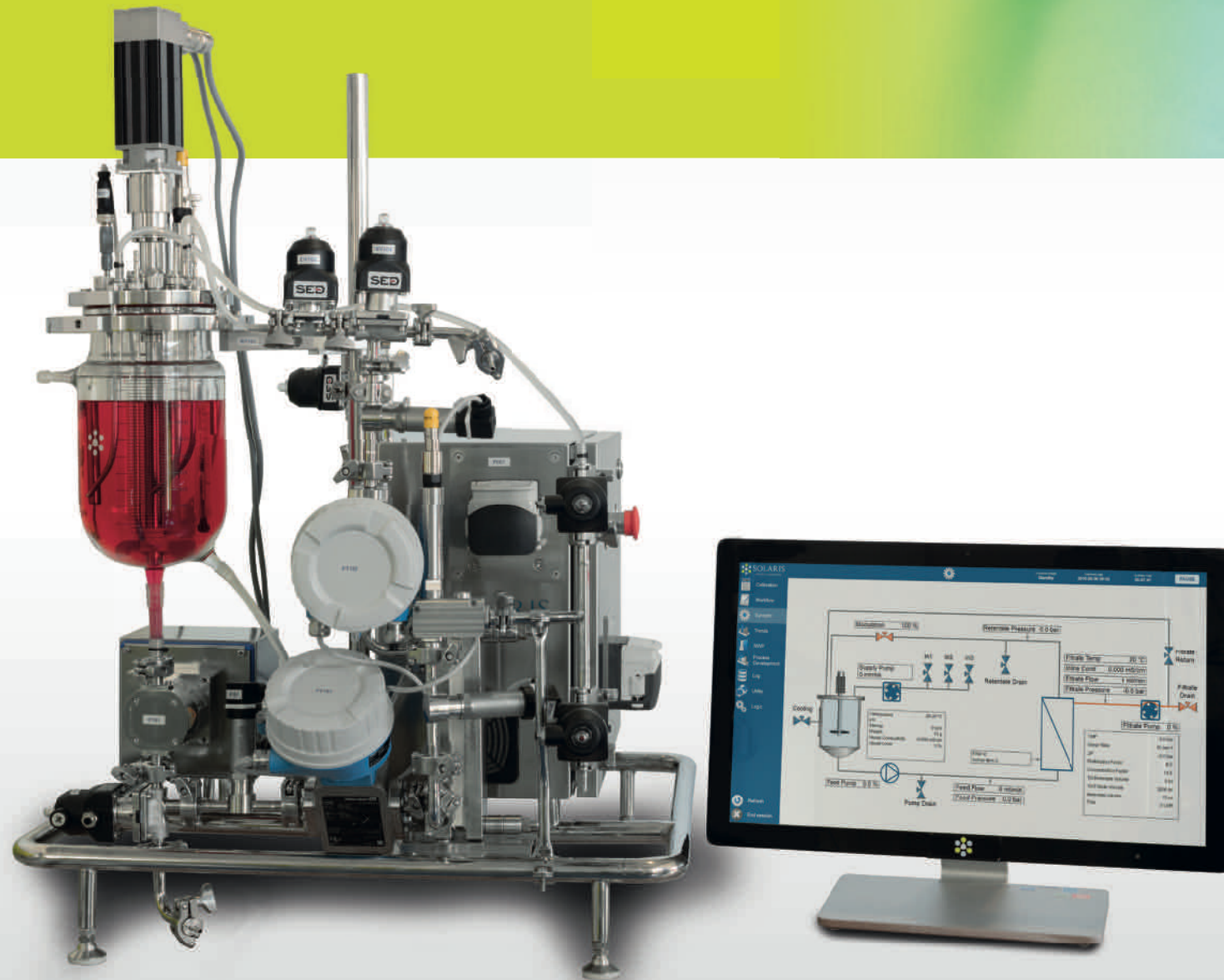

KRONOS is a standalone, benchtop, automatic Tangential Flow Filtration (TFF) system offering up to 0.5 m<sup>2</sup> total filtration area. Utilizing state of the art componentry, the system is equipped with powerful software enabling automatic process sequences, and innovative process development modules.

Typical applications includes the following:  
Basic research  
Scale-up and scale-down studies  
Process development and optimization

KRONOS can be used for:  
Biopharmaceutical  
Biofuels research and manufacturing  
Vaccines  
Food and beverage biotechnologies  
Bioremediation  
Bioplastics  
Cosmeceutical  
Nutraceutical

**Flexibility**  
the best membrane for  
each separation  
process

**OPTIMIZING**  
The ratio  
cost/profit



# AUTOMATIC AND FLEXIBLE TANGENTIAL FLOW FILTRATION SYSTEM

KRONOS

## Benefits

Powerful/ Accurate **brushless motor**, from 1 to 2000 RPM. Online absorbed Torques (Nm) and Power (W) measurements obtaining an indirect density indication of the culture broth

Available in 3 different volumes: 2L, 5L, 10L. Removable vessel

Integrated NPW test

Automatic process sequence  
Filtrate flow control

**Flexibility**  
the best membrane  
for each separation  
process

Modbus Digital Hamilton sensors

Fully removable and cleanable jacket

Small foot print to maximize lab space efficiency

Safety: pressure relief valve included in each unit

Remote access via PC, tablet/smartphone  
Remote control for after sale assistance

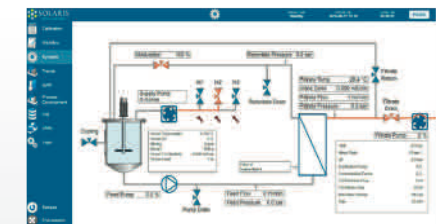
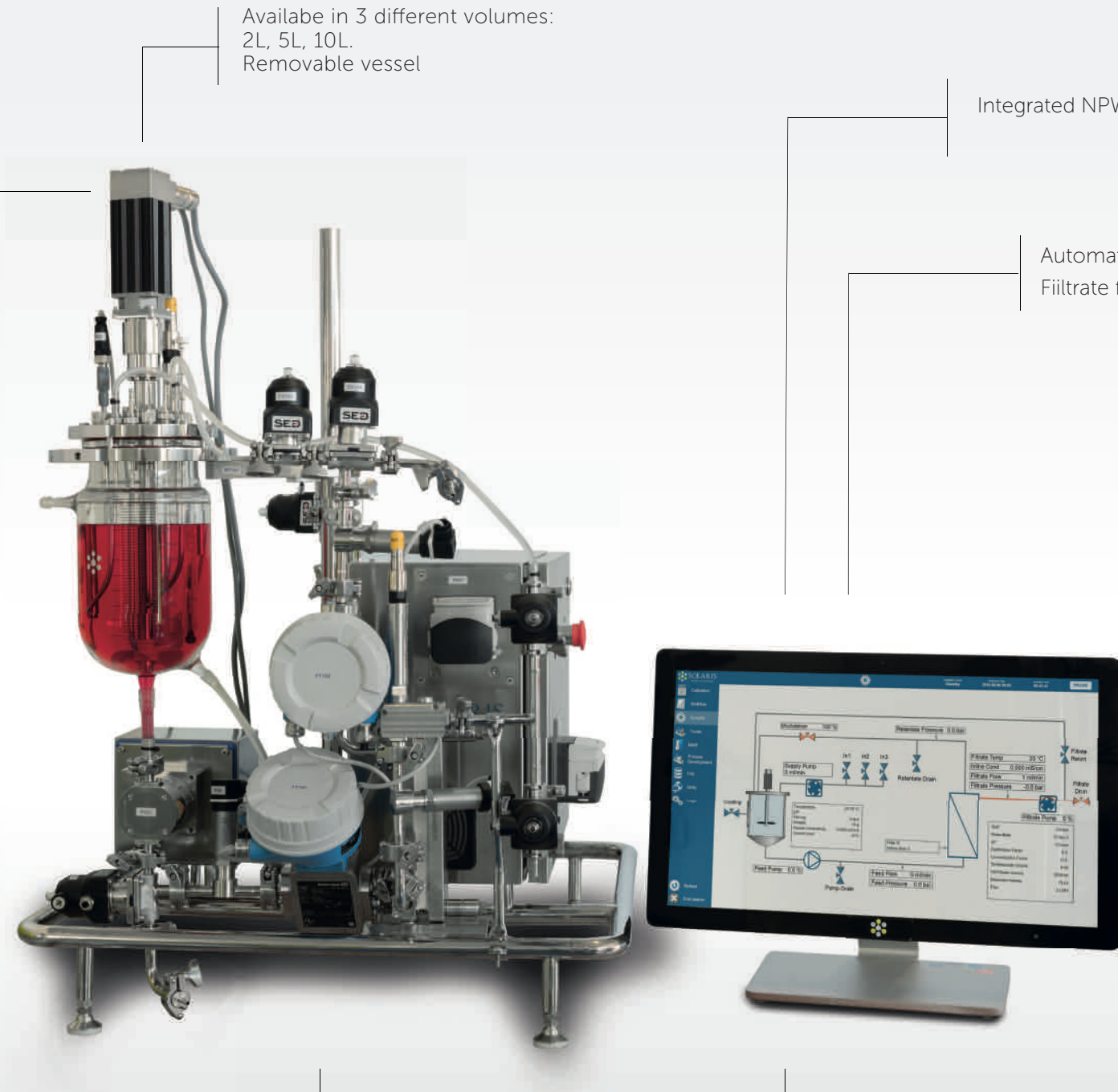



## Flexibility

Kronos can be equipped with various membrane types (hollow fiber, cassettes, ceramic) and is designed following the criteria of cGMP.

The included PLC based controller provides all functionality for parameter measurement and process control. The hardware layout is designed such that sensors, pumps, recirculation vessels, valves, etc., are conveniently located for operation and turn-around.



Solaris can assist in evaluating the best membrane for each application in terms of material, geometrical configuration, and working parameters to:

- minimize shear
- avoid the "gel" layer problem
- increase diafiltration efficiency

**Flexibility**  
the best membrane  
for each separation

## Modbus Digital sensors

### Why a digital sensor?

Digital sensors has been integrated to the Solaris PCS and controlling software giving the user many benefits over traditional analog sensor outputs. Such benefits include a robust communication protocol not susceptible to signal loss, in-software sensor diagnostic information, parallel calibrations/batch calibrations and more.

**Sensor life  
traceability**

**Reducing  
background noise**



## Data sheet

Kronos 0.5			
Total Volume (liters)	2,00	5,00	10,00
Hold up volume	70 ml		
Pump output	4-180 l/h		
Max. operating pressure	4 bar (g)		
Membranes available	Cassettes, Hollow fiber, Spiral wound, Ceramic		

Vessel Data	
Design	Borosilicate Glass Vessel with conical bottom
Materials	Vessel: Borosilicate Glass Lid: AISI 316L
Drive	Brushless Motor Direct Assembly
RPM	1-2600 RPM, Accuracy 1RPM
Impeller	Marine impeller
Weight	Load cell

## PCS and Software

PCS	S.S Cabinet AISI 304
HMI	23" Touch screen
Software	SCADA Solaris Software Control <b>Galileo</b>
Data Extraction	Through USB port or Ethernet
Graph trends, On line displaying and Printing	
On line parameter calibration	
Alarms Management	
Event recording	
Multipasswords level	
Integrated NPW test	

## Options

Transfer module	
Supply pump	Peristaltic pump. For diafiltration and large volume ultrafiltration.
Triple inlet valve	Automated valves for highly automated filtration process

Permeate module	
Filtrate pressure flow control pump Included flow meter	Prevent membrane fouling in microfiltration
pH measurement	Inline pH sensor
Conductivity measurement	Inline conductivity sensor
UV 280nm measurement	Inline UV prevent low yield or yield loss

Vessel upgrade options	
pH measurement	
Weight measurement through load cell	
Conductivity measurement	
Temperature measurement	
Level control via Sensor	Extra safety during manual operation

Holder option	
Hollow fiber holder	For single hollow fiber cartridge
Manifold for 3 hollow fiber cartridges	
Cassette holder	From various manufacturers

## Chiller

- Optionally KRONOS can be equipped with a chiller for heat removal from your culture minimizing lab water usage
- Using this system you don't need a water supply line in your lab
- Cost-effective cooling of fermenters
- Easy operation
- Refrigerant level monitoring



### Chiller data sheet

Working temperature range	-10°C / +40°C
Temperature stability	±0.5
Power consumption	0.7 kW
Filling volume range	2-8 L
Cooling output at 20°C measured with ethanol	0.25-0.60 kW
Cooling output at 10°C measured with ethanol	0.20-0.50 kW
Cooling output at 0°C measured with ethanol	0.15-0.36 kW
Cooling output at -10°C measured with ethanol	0.09-0.15 kW
Pump pressure max.	0.35-1.30 bar
Pump flow max.	16-35 L/min.
Dimensions (WxDxH)	200x350x465 mm





Solaris offers expertise in scale-up pilot and industrial scale TFF applications. Tytan series tangential flow filtration systems are tailored to each application by:

- utilizing the optimal membrane material
- optimizing flow path dimensions
- utilizing the best components and controlling parameters for each process

Solaris' approach to TFF technology aims to be in lock step with each customer's cost/profit analysis.

## TYTAN series



**TYTAN 100**  
Micro/  
Ultrafiltration Unit  
Equipped with  
ceramic tubular  
membranes

**TYTAN 500**  
Microfiltration Unit

The **TYTAN series** is based on Microfiltration and Ultrafiltration techniques and operates in the low pressure range of 1-5 bar.

Available membranes:

- spiral wound
- hollow fiber
- cassettes
- tubular ceramic



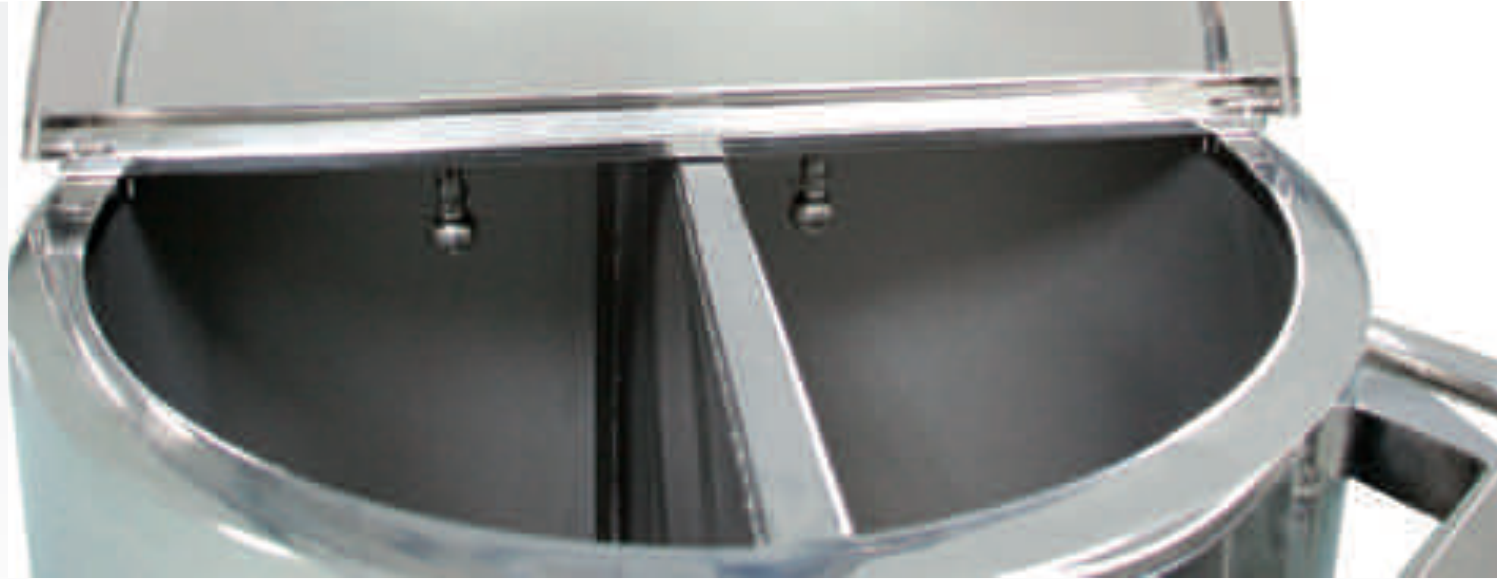

Solaris manufactures C.I.P. / S.I.P. SYSTEMS for repeatable processes under the strong hygienic regulations demanded by the pharmaceutical, biotechnology, food, dairy and beverage industries.

Single or Multi-tank configurations are available; multi tank configurations offer independent vessels for water of different quality, like deionized water (DI), hot or cold water for injection (WFI), reverse osmosis water (RO), etc. Cyclical controller and software sequences are available (e.g. wash down rinse, acid wash, alkaline wash, wash down, final wash). Systems are capable of fully automatic or manual operations.



Processes are managed via PLC based controller, integrated to the CIP/SIP unit. The touch screen HMI is utilized for setting up: task sequencing/repetition, process volumes (water, WFI, etc.), detergent dosages, CIP fluid temperature, wash pressure, purging (drainage of equipment and CIP/SIP unit with compressed air), etc.



Solaris offers in-house training in various bioprocessing related disciplines. Such courses and programs can be tailored to the individual group's needs, with focus on relative theory and hands-on experience. Topics can include fermentation/cell culture procedural best practices including setup and process procedure, theoretical process understanding, component/equipment training, etc.

Many research institutions and startups have also utilized Solaris's available lab space for initial process testing - greatly assisting their eventual product selection, configuration, customization, etc. Such efforts are collaborative and can be executed by Solaris' technicians or by the party in interest.

In the field, Solaris offers full product training on purchased equipment and relative processes. Such training is available during installation or "on-call" for new operators, interested stakeholders, etc.

Solaris' research & development department, named MICRO MUNDI, is focused on the advancement of process technology in fermentation, microbiology, analysis and recovery. Solaris' background includes particular expertise in issues associated with commercial scale production, especially in scaling up from the lab or pilot plant.

The R&D center is a fully equipped space designed for process development. Available equipment ranges from benchtop to pilot scale, encompassing 4 major areas:

1. Strain screening and selection
2. Fermentation
3. Downstream processing
4. Analytical development

The development of technologies is based on:

1. Strain selection, maintenance and improvement
2. Consideration to metabolic, chemical and physical parameters useful to optimization.

Solaris extensive experiences in the development of strictly confidential technologies. These projects were treated such that all biological and intellectual results were and remain the property of the client. Micro Mundi resources have been utilized in fields such as:

- Classical fermentation ( API, anti-tumorals, vitamins, etc)
- Biofuel production
- Cell plant fermentation
- Bioremediation
- Mammalian cell culture



MICRO MUNDI's staff offers a wealth of experience ranging from process engineer to various fields of research science within the biotechnology, pharmaceutical and F&B industries. This experience enables Solaris to be a trusted partner in the implementation of development or improved technologies.



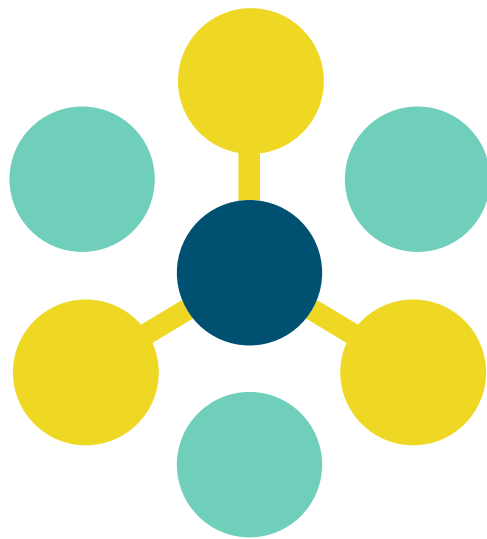

SOLARIS  
BIOTECH SOLUTIONS